



TURN SPACE INTO VALUE

SHELVINGS - TROLLEYS - FOOD EQUIPMENT

2025 CATALOG

WWW.TONON.COM



HACCP



DESIGNING AND MANUFACTURING CERTIFIED EQUIPMENT FOR THE FOOD INDUSTRY SINCE 1946

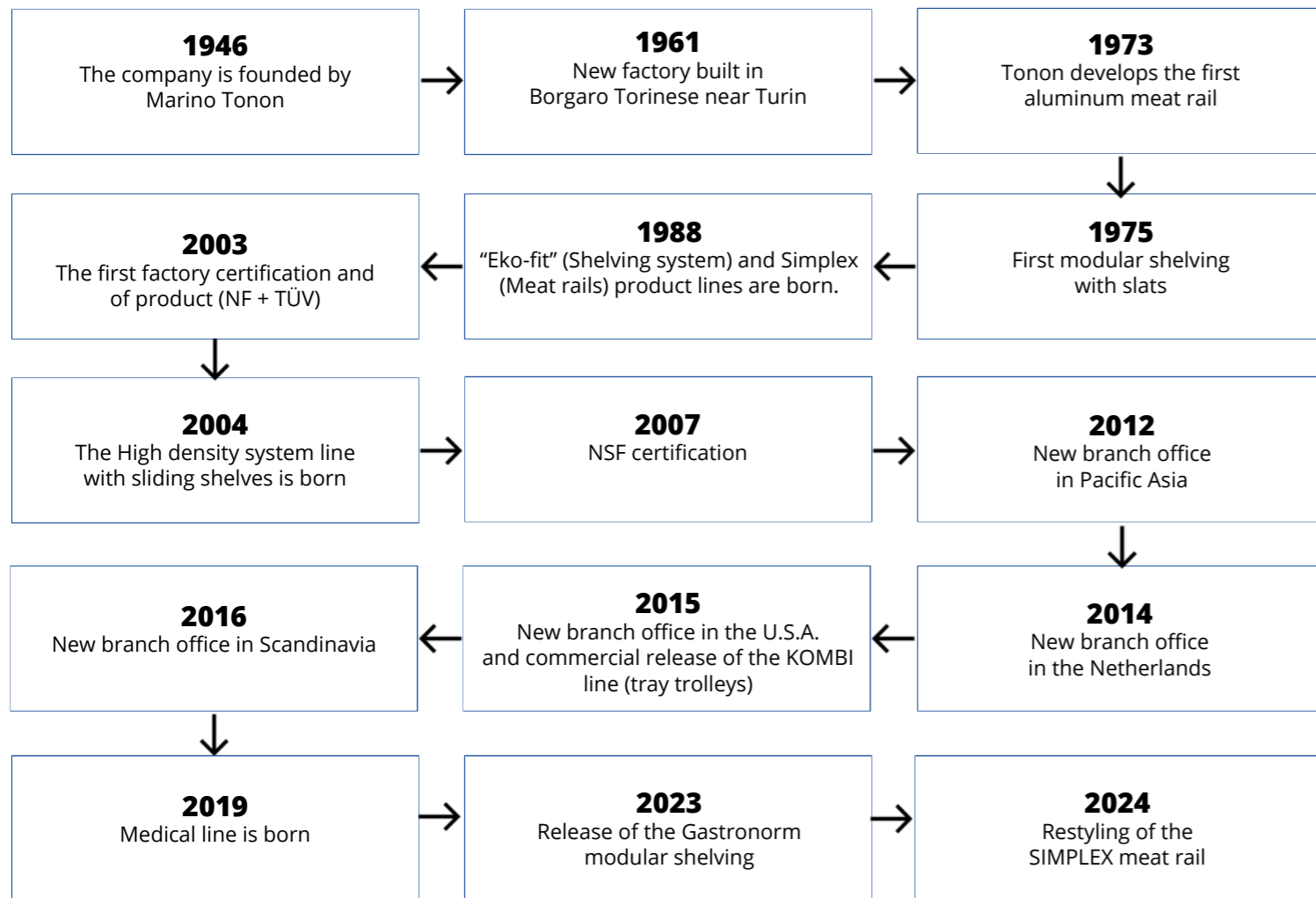

Tonon has been in business since 1946 and is currently managed by the third generation of the Tonon family from Turin.

In large as well as in small companies related to the food sector, there is an increasingly pressing need to adopt equipment that allows easier and faster production, excellent hygienic results, better preservation of the product, and above all, the elimination of the considerable labors required by the use of inadequate systems.

To this end, our company, which devotes its activity to the solutions of problems inherent in the food industry, allows itself to present in this catalog its production, certain to satisfy the most diverse needs.



Eric and Luca Tonon

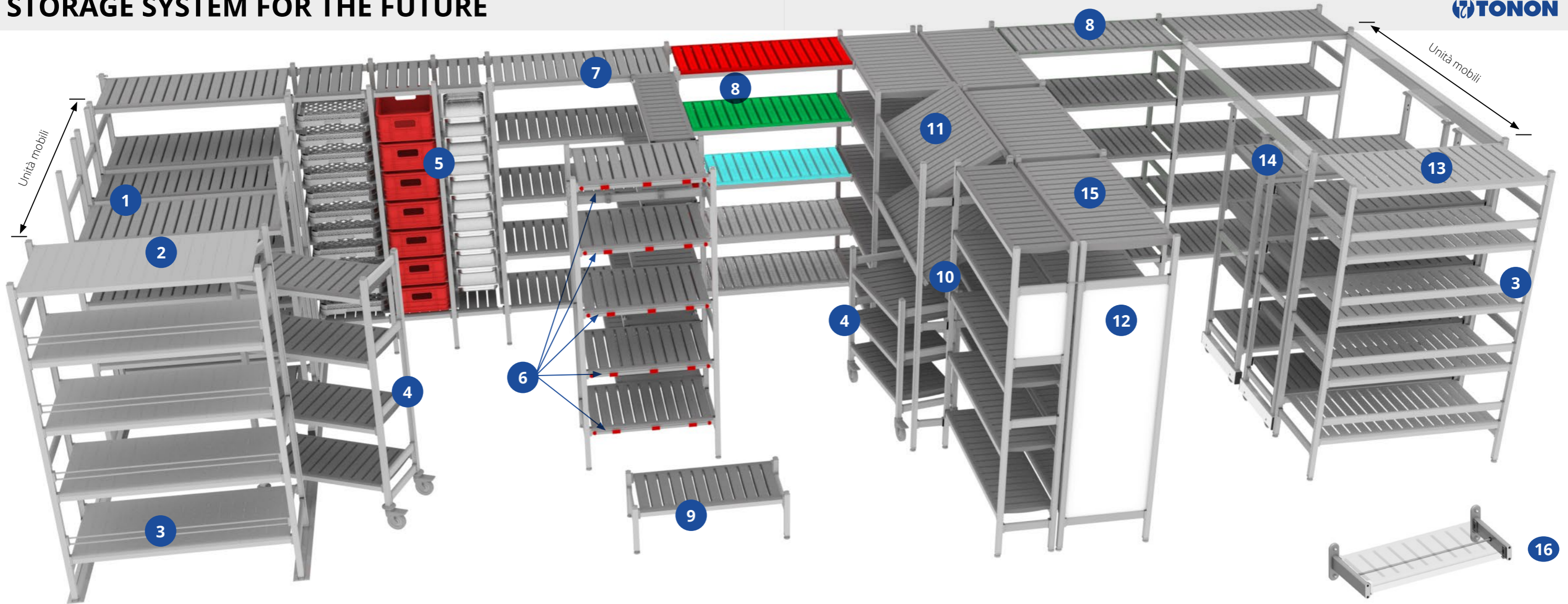

- 1** High density system - Floor rail
pag. 54
- 2** Shelf with aluminum solid slats
pag. 23
- 3** Light or heavy duty fall arresting bars
pag. 29
- 4** Shelving trolleys of various sizes
pag. 60
- 5** Shelving with L-shaped rails
pag. 40
- 6** Label holder
pag. 35
- 7** Corner kit
pag.22-23
- 8** Colored PE-HD shelves
pag. 24-25
- 9** Bench
pag. 34
- 10** Integration frame
pag. 26

- 11** Display shelf
pag. 25
- 12** Frame with side panel
pag. 27
- 13** Grey PE-HD shelves (STANDARD)
pag. 22
- 14** High density system - Upper rail
pag. 56
- 15** Shelf with aluminum vented slats
pag. 23
- 16** Wall mounted shelf
pag. 36
- 17** Shelving Kit
pag. 37
- 18** BLACK Series
pag. 48
- 19** KOMBI tray trolleys
pag. 64



On these pages we report a small selection of the wide variety of solutions currently in use around the world. Each has been individually adapted-and yours will be, too.

Washing solution



Storage of dry goods



Cold storage room



Display shelving



Gastronomy



Environment for maturing meat



Frame with side panel for notes



FIFO storage structure



Mobile storage units



Requirements for food storage are increasingly restrictive and require a very high level of hygiene and safety.

Tonon products satisfy the standards as they have received the level of certification for food storage.

When deciding which materials to use for our items, we consider all parameters, including, of course, the safety of our customers.

		<p>High-density polyethylene The same material used for cutting boards in the kitchen.</p>
		<p>Anodized aluminum The same one used to preserve food.</p>

Rustproof

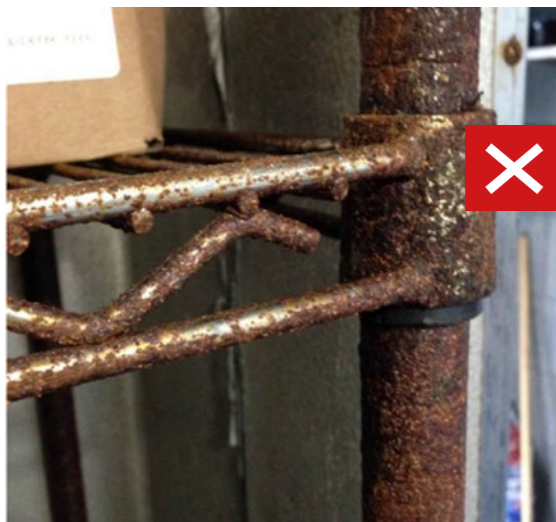

Certified product



NSF International - P.O. Box 130140 Ann Arbor Michigan - USA - Standard 02

Conformity certification according to NSF Ansi Standard 02 (America, Africa, Asia and Oceania) for aptitude for cleaning, aptitude for working, toxicological evaluation of materials.

Maintenance of the mark includes an annual audit at our factories.





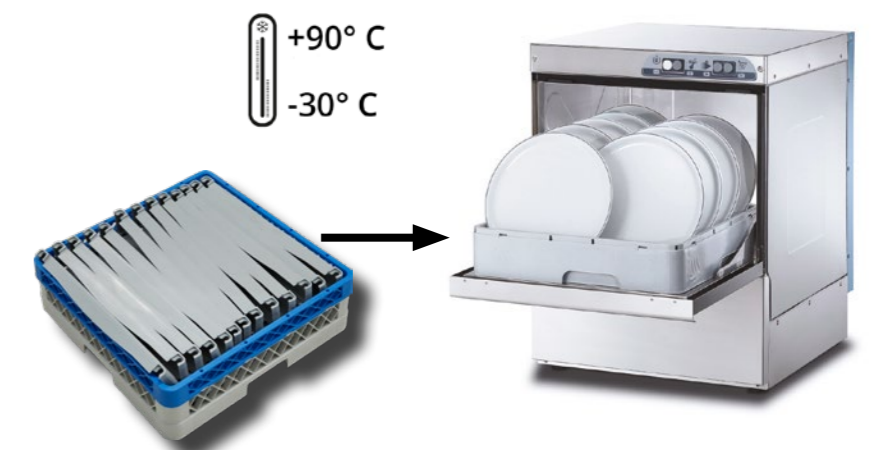











Easy to clean

Our shelving is easy to clean because the aluminum support structure has no protrusions or exposed bolts. Its slats, both polyethylene and aluminum, are easily disassembled and washable in dishwashers according to HACCP standards.





MODULAR SHELVING
TOP Series

-  Load capacity: up to 550 lbs (250 kg) per shelf
-  Simple click-assembly of the shelves, ensuring ultimate flexibility and strength
-  Exclusive use of stainless steel screws - none of them visible
-  Eco-friendly from production to use
-  Temperature range: da -30°C (-22°F) a +90°C (+194°F)
-  Flat packaging = less freight costs
-  Ideal for cold and freezer rooms - no frost issues with cardboard boxes
-  Approved and suitable for direct food contact
-  Long life service
-  No special tools needed for assembly
-  Lightweight
-  Easy to clean
-  Fast assembly
-  International hygiene certifications (NSF)
-  NO RUST - 20 micron anodized aluminum
-  Length precision < 3 cm



Linear



Add-on



Angular



"U" shape



IDEAL FOR COLD ROOM STORAGE

Our shelving system is available in many different configurations and it perfectly fits in any kind of walk in cold room.

8 heights

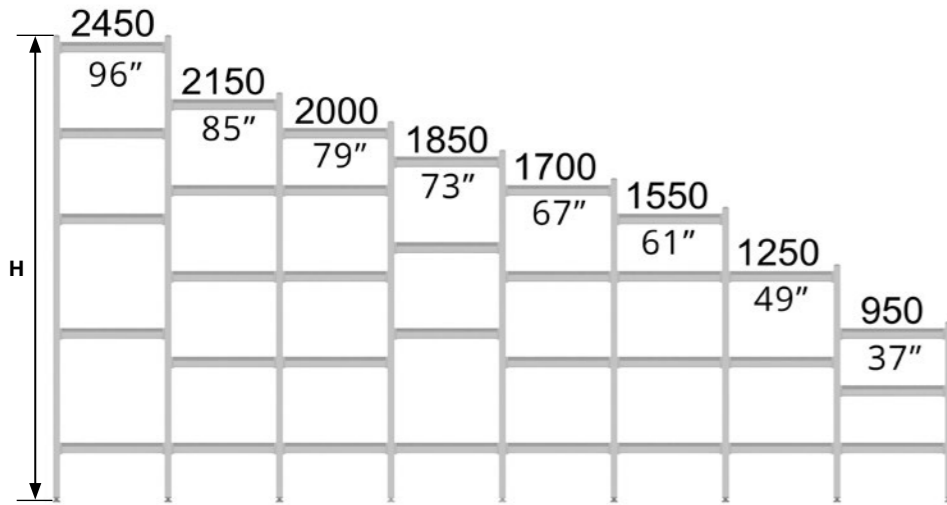

Easy to clean

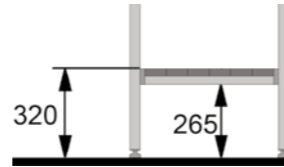

75 mm (3") modularity



75 mm (3")
Slat width

5 depths (W), 22 lengths (L)

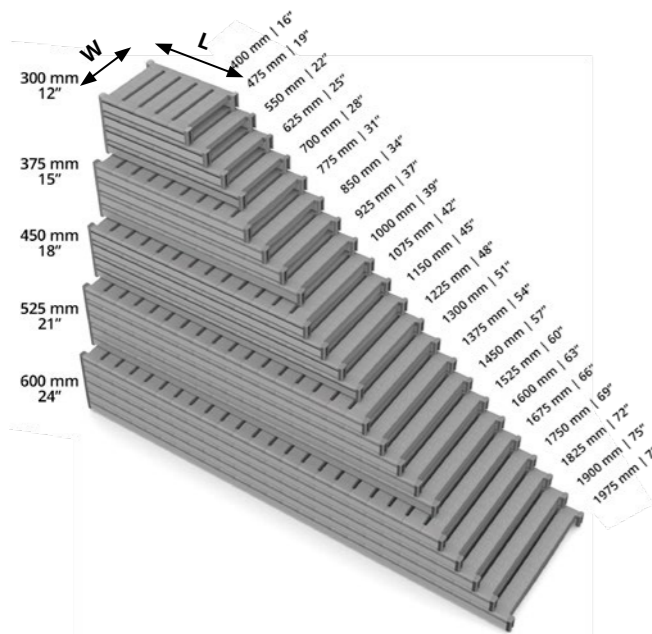

Data common to all shelves widths
(12" - 15" - 18" - 21" - 24") (300 - 375 - 450 - 525 - 600 mm)

Length		Load capacity		Slats	Length		Load capacity		Slats
mm	in.	kg	lbs		mm	in.	kg	lbs	
400	16	250	550	5	1225	48	220	485	16
475	19	250	550	6	1300	51	200	440	17
550	22	250	550	7	1375	54	200	440	18
625	25	250	550	8	1450	57	200	440	19
700	28	250	550	9	1525	60	180	400	20
775	31	250	550	10	1600	63	180	400	21
850	34	250	550	11	1675	66	180	400	22
925	37	240	530	12	1750	69	150	330	23
1000	39	240	530	13	1825	72	150	330	24
1075	42	220	485	14	1900	75	120	260	25
1150	45	220	485	15	1975	78	110	240	26

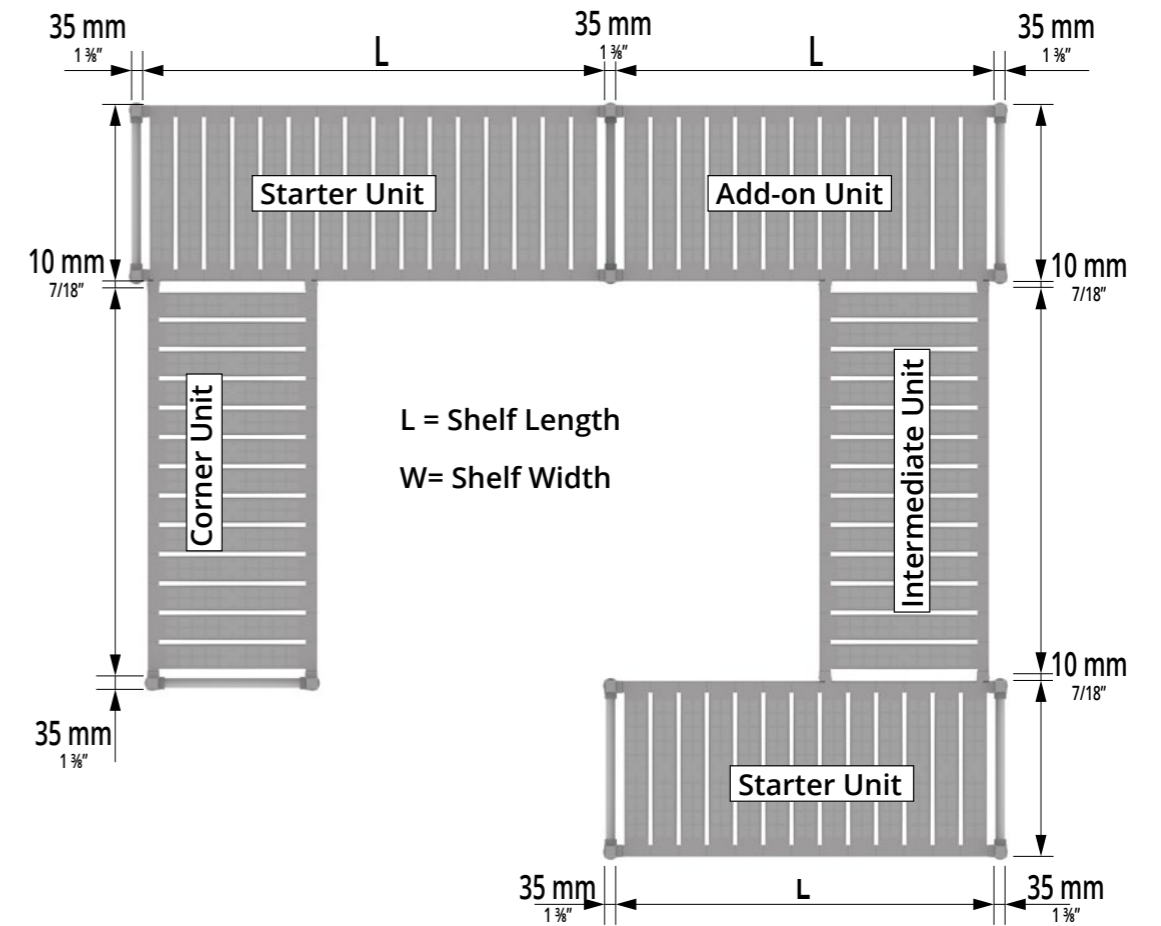
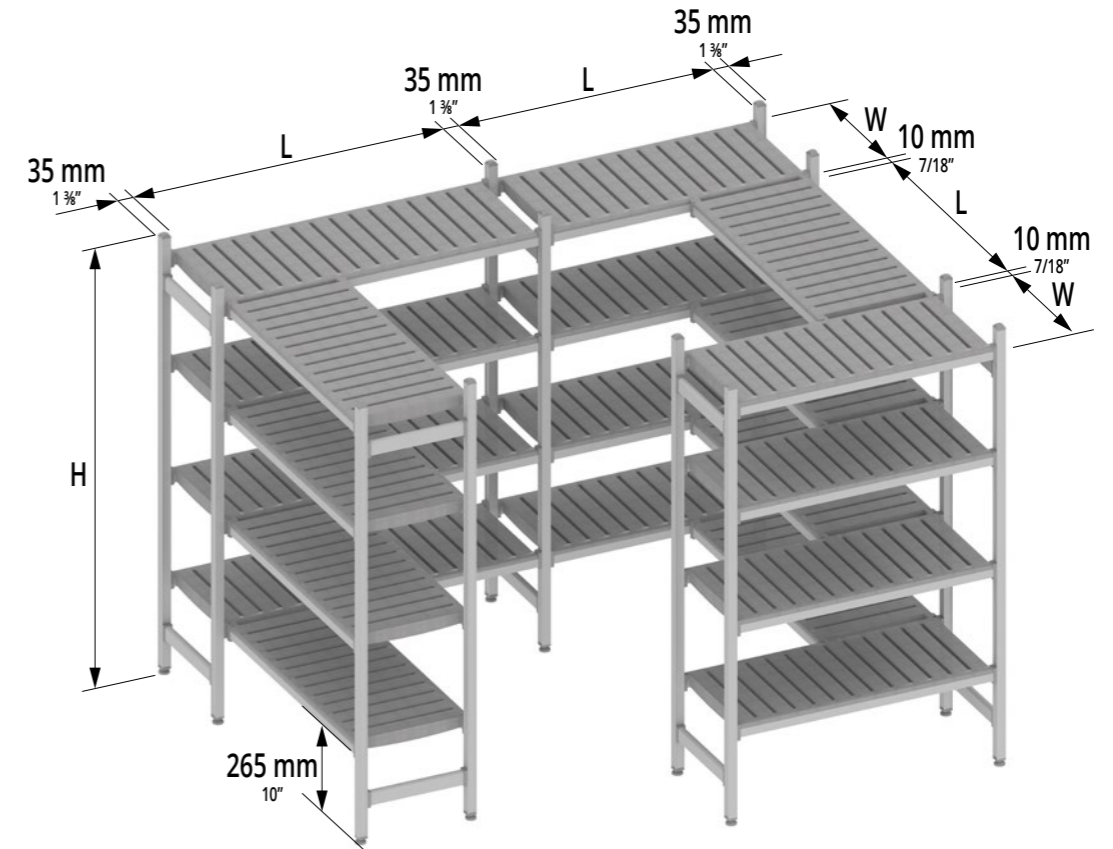

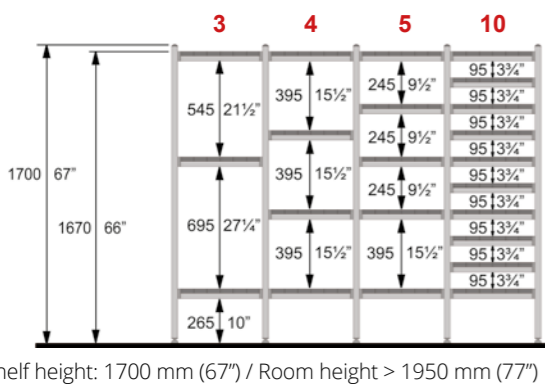
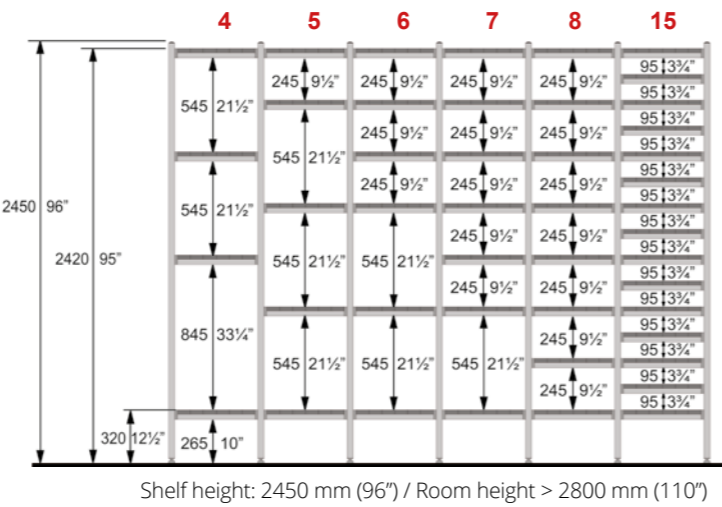
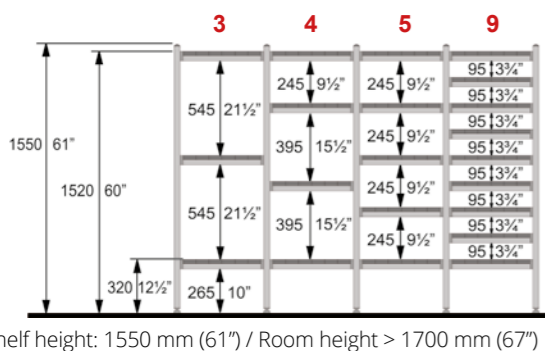
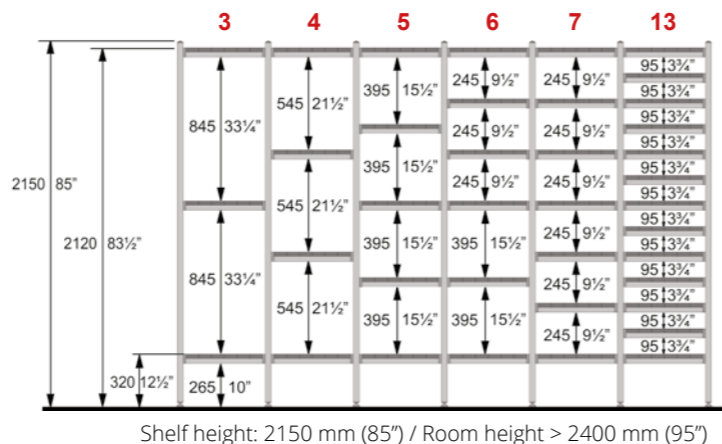
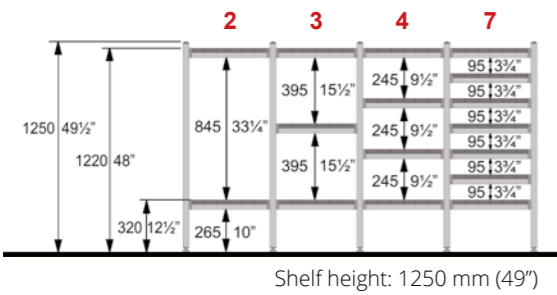
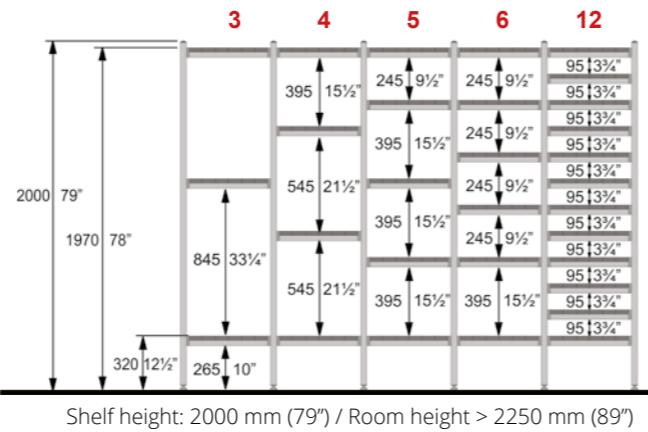
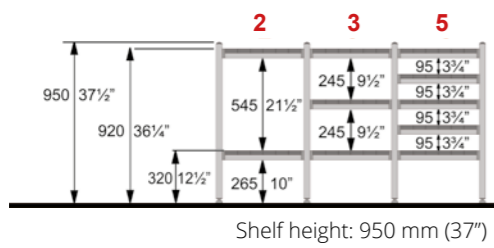
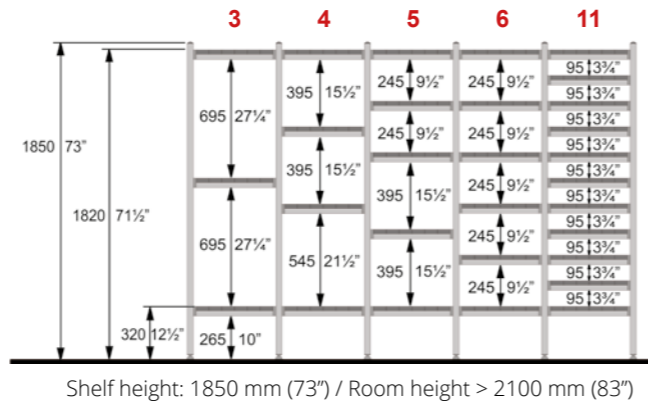
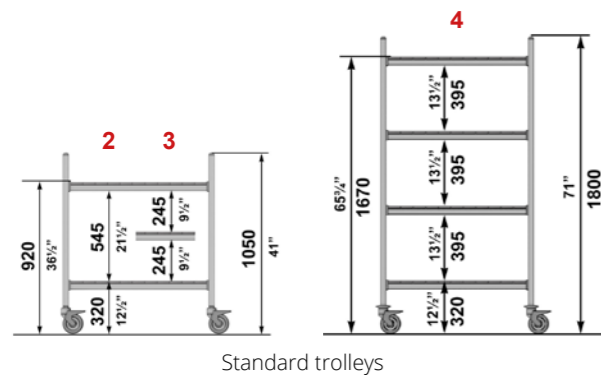

The assembly of the starter unit takes less than 5 minutes

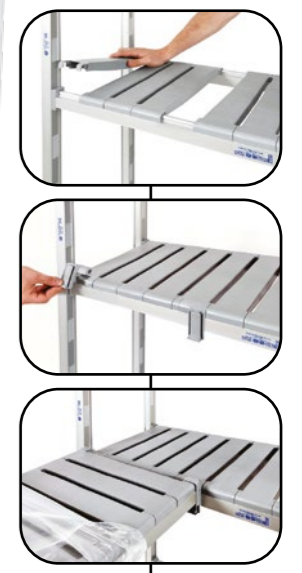

With the corner kit you can increase and optimize the storage



When you install Tonon's shelving system leave the plastic wrap on it. This will keep the shelving 100% clean until the very last moment when products will arrive in the cold room.

With Eko-Fitter software, it is possible to create preemptions of modular shelving in minutes.

Fully customizable, Eko-fitter can create 2D or 3D layouts for immediate technical and aesthetic feedback of the environment to be furnished.

Our technical staff is available for any needs in this regard.

AUTOMATIC CALCULATION

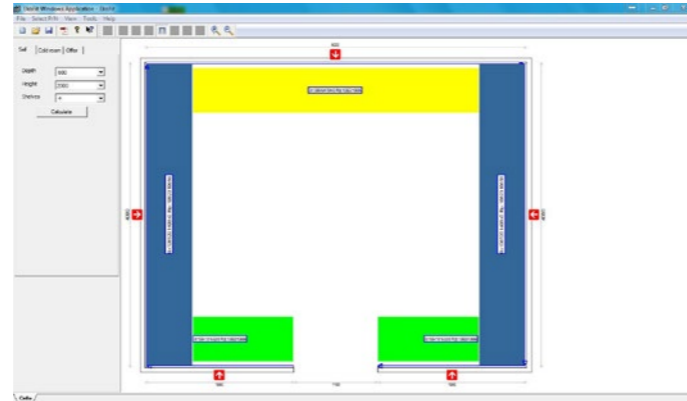

2D VIEW

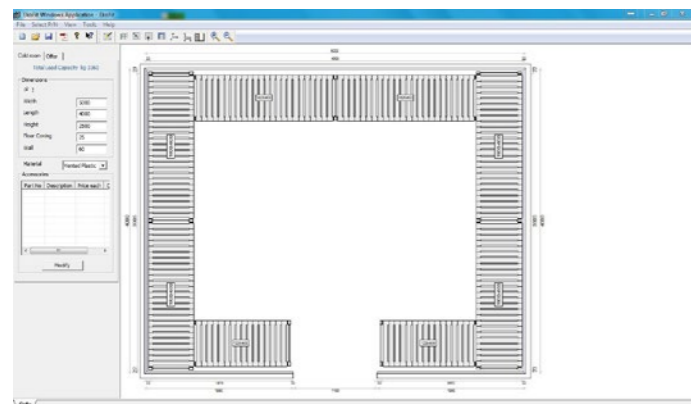

3D VIEW

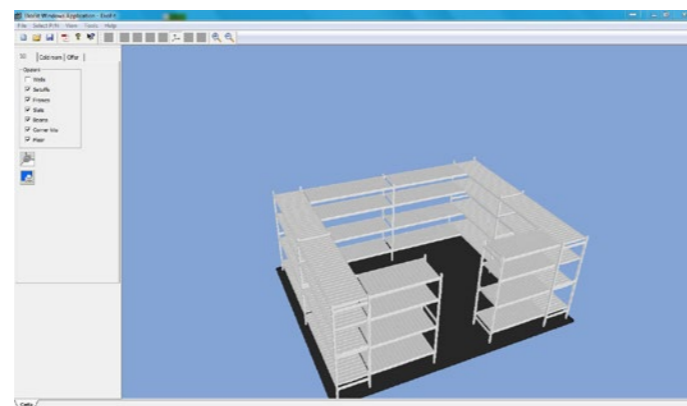

- 1 Absence of corner posts obstructing access to products.
- 2 All joints are concealed so there are no screws or other fittings to get caught or cut on.
- 3 Both aluminum and PE-HD slats are devoid of sharp edges.
- 4 As none of our materials can rust, they cannot develop hazardous burrs or peeling.
- 5 Our slats prevent packaging from freezing to the shelf and thus being ruined and posing a handling risk.
- 6 Specification of load capacity on every single shelf protects against overloading.

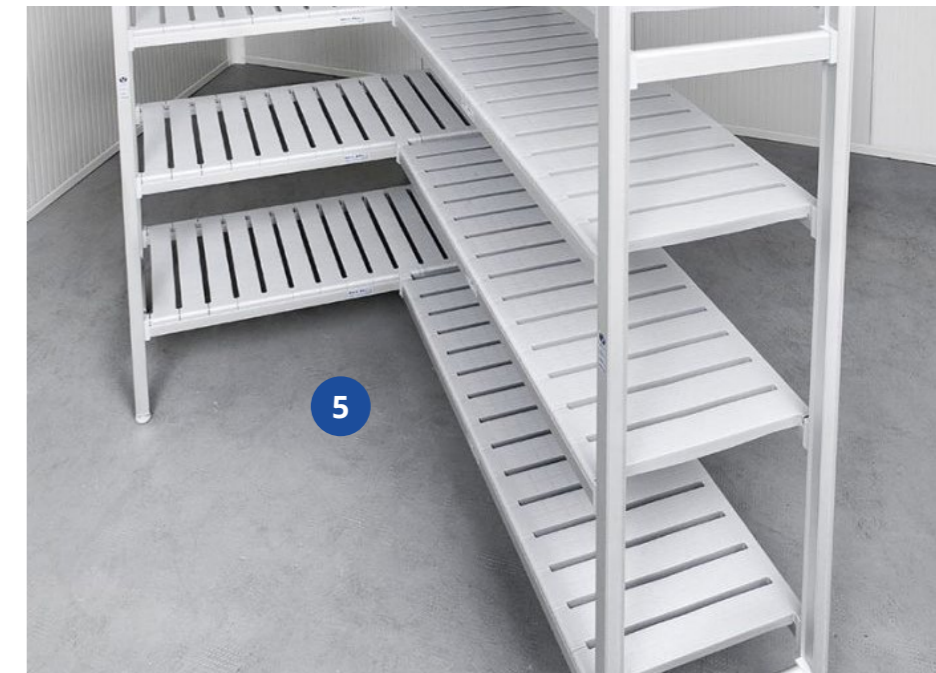
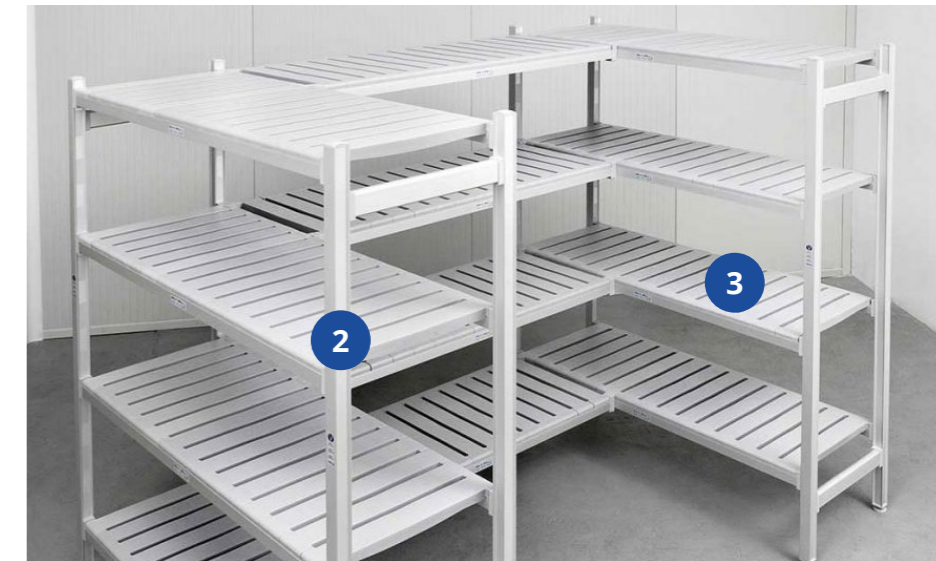
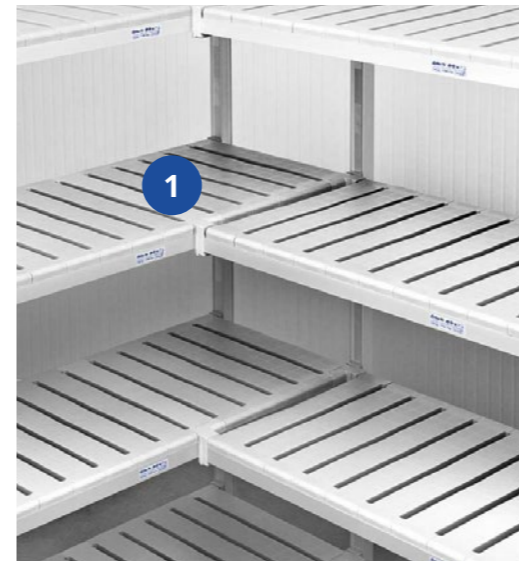

As everyone knows, the ISO standard is a fundamental concept for the entire cycle of logistics and warehouse management, because it ensures optimal storage.

In fact, all cardboard items are designed for 800 x 1200 mm Euro model pallets.

While we consider the value of aesthetics to be fundamental, it would not make sense for us not to consider the importance of designing items if not based on ISO standards.

This is the only way we can be sure that our customers' storage space is used to the fullest.

Legend:



X = Number of boxes 400 x 600 mm (16" x 24") per shelf of the shelving

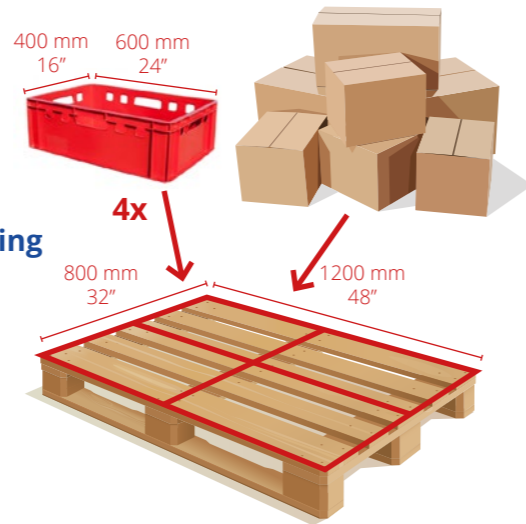

20 cm (7") NOT used in a 1 m (3' 3") section (-20%)

Examples:

ISO-FACTOR® X=2	ISO-FACTOR® X=2	ISO-FACTOR® X=3	ISO-FACTOR® X=4
925 x 600 37" x 24"	1300 x 450 51" x 18"	1300 x 600 51" x 24"	1675 x 600 66" x 24"
850 x 600 34" x 24"	1225 x 450 48" x 18"	1225 x 600 48" x 24"	
600 x 400 24" x 16"	600 x 400 24" x 16"	600 x 400 24" x 16"	600 x 400 24" x 16"
600 x 400 24" x 16"		600 x 400 24" x 16"	600 x 400 24" x 16"



Ideal use of storage space

ALUMINUM TERMINAL FRAME

Height (H)	Load Capacity (UDL)		Width (W)	Width (W)	Width (W)	Width (W)	Width (W)	
	kg	lbs	300 mm - 12"	375 mm - 15"	450 mm - 18"	525 mm - 21"	600 mm - 24"	
mm	in.		P/N	P/N	P/N	P/N	P/N	
950	37	1000	2200	KFT290	KFT365	KFT440	KFT515	KFT590
1250	49	1000	2200	KFT294	KFT369	KFT444	KFT519	KFT594
1550	61	1000	2200	KFT298	KFT373	KFT448	KFT523	KFT598
1700	67	1000	2200	KFT300	KFT375	KFT450	KFT525	KFT600
1850	73	1000	2200	KFT301	KFT376	KFT451	KFT526	KFT601
2000	79	1000	2200	KFT302	KFT377	KFT452	KFT527	KFT602
2150	85	1000	2200	KFT303	KFT378	KFT453	KFT528	KFT603
2450	96	1000	2200	KFT304	KFT379	KFT454	KFT529	KFT604

ALUMINUM CENTRAL FRAME

Height (H)	Load Capacity (UDL)		Width (W)	Width (W)	Width (W)	Width (W)	Width (W)	
	kg	lbs	300 mm - 12"	375 mm - 15"	450 mm - 18"	525 mm - 21"	600 mm - 24"	
mm	in.		P/N	P/N	P/N	P/N	P/N	
950	37	1000	2200	KFC290	KFC365	KFC440	KFC515	KFC590
1250	49	1000	2200	KFC294	KFC369	KFC444	KFC519	KFC594
1550	61	1000	2200	KFC298	KFC373	KFC448	KFC523	KFC598
1700	67	1000	2200	KFC300	KFC375	KFC450	KFC525	KFC600
1850	73	1000	2200	KFC301	KFC376	KFC451	KFC526	KFC601
2000	79	1000	2200	KFC302	KFC377	KFC452	KFC527	KFC602
2150	85	1000	2200	KFC303	KFC378	KFC453	KFC528	KFC603
2450	96	1000	2200	KFC304	KFC379	KFC454	KFC529	KFC604

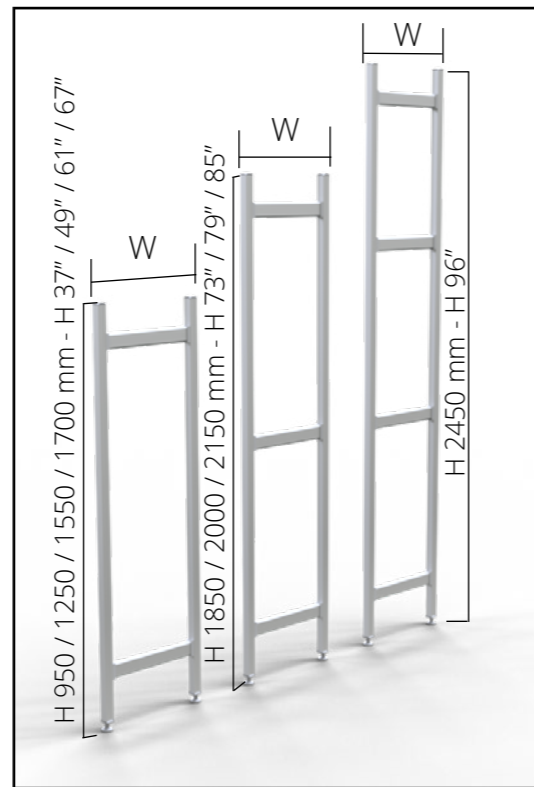

VENTED ALUMINUM SHELF WITH ALUMINUM SLATS

Height (H)	Load Capacity (UDL)		Width (W)	Width (W)	Width (W)	Width (W)	Width (W)	
	kg	lbs	300 mm - 12"	375 mm - 15"	450 mm - 18"	525 mm - 21"	600 mm - 24"	
mm	in.		P/N	P/N	P/N	P/N	P/N	
400	16	250	550	KFL292	KFL367	KFL442	KFL517	KFL592
475	19	250	550	KFL294	KFL369	KFL444	KFL519	KFL594
550	22	250	550	KFL296	KFL371	KFL446	KFL521	KFL596
625	25	250	550	KFL298	KFL373	KFL448	KFL523	KFL598
700	28	250	550	KFL300	KFL375	KFL450	KFL525	KFL600
775	31	250	550	KFL302	KFL377	KFL452	KFL527	KFL602
850	34	250	550	KFL304	KFL379	KFL454	KFL529	KFL604
925	37	240	530	KFL306	KFL381	KFL456	KFL531	KFL606
1000	39	240	530	KFL308	KFL383	KFL458	KFL533	KFL608
1075	42	220	485	KFL310	KFL385	KFL460	KFL535	KFL610
1150	45	220	485	KFL312	KFL387	KFL462	KFL537	KFL612
1225	48	220	485	KFL314	KFL389	KFL464	KFL539	KFL614
1300	51	200	440	KFL316	KFL391	KFL466	KFL541	KFL616
1375	54	200	440	KFL318	KFL393	KFL468	KFL543	KFL618
1450	57	200	440	KFL320	KFL395	KFL470	KFL545	KFL620
1525	60	180	400	KFL322	KFL397	KFL472	KFL547	KFL622
1600	63	180	400	KFL324	KFL399	KFL474	KFL549	KFL624
1675	66	180	400	KFL326	KFL401	KFL476	KFL551	KFL626
1750	69	150	330	KFL328	KFL403	KFL478	KFL553	KFL628
1825	72	150	330	KFL330	KFL405	KFL480	KFL555	KFL630
1900	75	120	260	KFL332	KFL407	KFL482	KFL557	KFL632
1975	78	110	240	KFL334	KFL409	KFL484	KFL559	KFL634

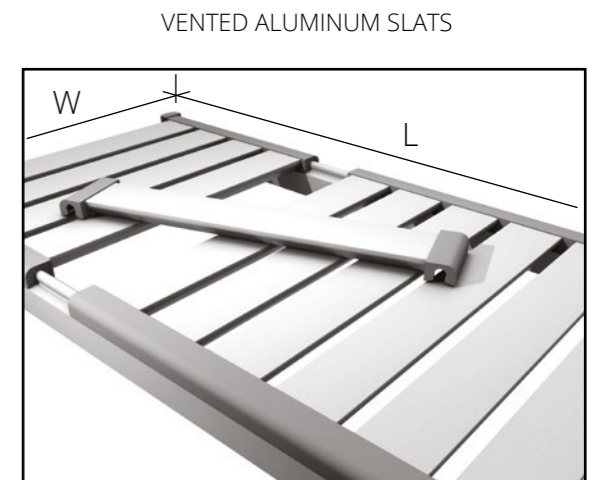

Including 4 connecting plastic clips to the frames

VENTED ALUMINUM SHELF WITH PLASTIC SLATS

Height (H)	Load Capacity (UDL)		Width (W)	Width (W)	Width (W)	Width (W)	Width (W)	
	kg	lbs	300 mm - 12"	375 mm - 15"	450 mm - 18"	525 mm - 21"	600 mm - 24"	
mm	in.		P/N	P/N	P/N	P/N	P/N	
400	16	250	550	KFS292	KFS367	KFS442	KFS517	KFS592
475	19	250	550	KFS294	KFS369	KFS444	KFS519	KFS594
550	22	250	550	KFS296	KFS371	KFS446	KFS521	KFS596
625	25	250	550	KFS298	KFS373	KFS448	KFS523	KFS598
700	28	250	550	KFS300	KFS375	KFS450	KFS525	KFS600
775	31	250	550	KFS302	KFS377	KFS452	KFS527	KFS602
850	34	250	550	KFS304	KFS379	KFS454	KFS529	KFS604
925	37	240	530	KFS306	KFS381	KFS456	KFS531	KFS606
1000	39	240	530	KFS308	KFS383	KFS458	KFS533	KFS608
1075	42	220	485	KFS310	KFS385	KFS460	KFS535	KFS610
1150	45	220	485	KFS312	KFS387	KFS462	KFS537	KFS612
1225	48	220	485	KFS314	KFS389	KFS464	KFS539	KFS614
1300	51	200	440	KFS316	KFS391	KFS466	KFS541	KFS616
1375	54	200	440	KFS318	KFS393	KFS468	KFS543	KFS618
1450	57	200	440	KFS320	KFS395	KFS470	KFS545	KFS620
1525	60	180	400	KFS322	KFS397	KFS472	KFS547	KFS622
1600	63	180	400	KFS324	KFS399	KFS474	KFS549	KFS624
1675	66	180	400	KFS326	KFS401	KFS476	KFS551	KFS626
1750	69	150	330	KFS328	KFS403	KFS478	KFS553	KFS628
1825	72	150	330	KFS330	KFS405	KFS480	KFS555	KFS630
1900	75	120	260	KFS332	KFS407	KFS482	KFS557	KFS632
1975	78	110	240	KFS334	KFS409	KFS484	KFS559	KFS634

LIGHT GRAY POLYETHYLENE SLATS

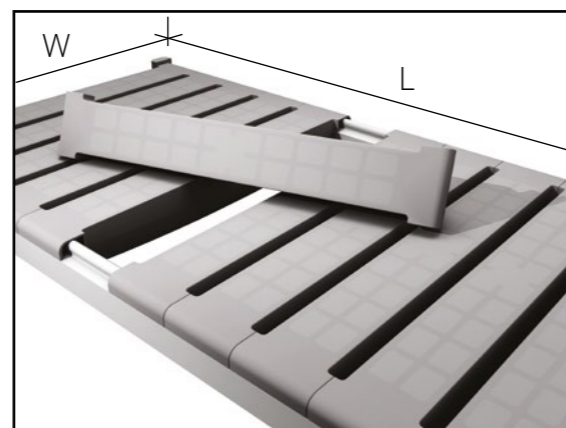

Including 4 connecting plastic clips to the frames

SOLID ALUMINUM SHELF WITH ALUMINUM SLATS

Height (H)	Load Capacity (UDL)		Width (W)	Width (W)	Width (W)	Width (W)	Width (W)	
	kg	lbs	300 mm - 12"	375 mm - 15"	450 mm - 18"	525 mm - 21"	600 mm - 24"	
mm	in.		P/N	P/N	P/N	P/N	P/N	
400	16	250	550	KFP292	KFP367	KFP442	KFP517	KFP592
475	19	250	550	KFP294	KFP369	KFP444	KFP519	KFP594
550	22	250	550	KFP296	KFP371	KFP446	KFP521	KFP596
625	25	250	550	KFP298	KFP373	KFP448	KFP523	KFP598
700	28	250	550	KFP300	KFP375	KFP450	KFP525	KFP600
775	31	250	550	KFP302	KFP377	KFP452	KFP527	KFP602
850	34	250	550	KFP304	KFP379	KFP454	KFP529	KFP604
925	37	240	530	KFP306	KFP381	KFP456	KFP531	KFP606
1000	39	240	530	KFP308	KFP383	KFP458	KFP533	KFP608
1075	42	220	485	KFP310	KFP385	KFP460	KFP535	KFP610
1150	45	220	485	KFP312	KFP387	KFP462	KFP537	KFP612
1225	48	220	485	KFP314	KFP389	KFP464	KFP539	KFP614
1300	51	200	440	KFP316	KFP391	KFP466	KFP541	KFP616
1375	54	200	440	KFP318	KFP393	KFP468	KFP543	KFP618
1450	57	200	440	KFP320	KFP395	KFP470	KFP545	KFP620
1525	60	180	400	KFP322	KFP397	KFP472	KFP547	KFP622
1600	63	180	400	KFP324	KFP399	KFP474	KFP549	KFP624
1675	66	180	400	KFP326	KFP401	KFP476	KFP551	KFP626
1750	69	150	330	KFP328	KFP403	KFP478	KFP553	KFP628
1825	72	150	330	KFP330	KFP405	KFP480	KFP555	KFP630
1900	75	120	260	KFP332	KFP407	KFP482	KFP557	KFP632
1975	78	110	240	KFP334	KFP409	KFP484	KFP559	KFP634

SOLID ALUMINUM SLATS

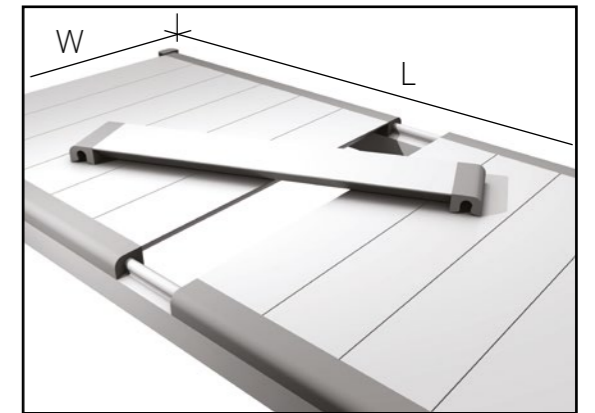

Including 4 connecting plastic clips to the frames

POLYETHYLENE CORNER KIT

Shelf Type	Width (W)	Width (W)	Width (W)	Width (W)	Width (W)
	300 mm - 12"	375 mm - 15"	450 mm - 18"	525 mm - 21"	600 mm - 24"
	P/N	P/N	P/N	P/N	P/N
Vented	KFA300	KFA375	KFA450	KFA525	KFA600

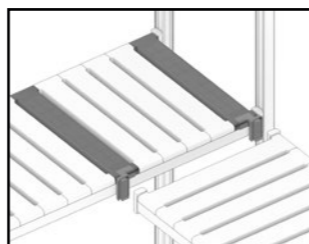

ALUMINUM CORNER KIT

Shelf Type	Width (W)	Width (W)	Width (W)	Width (W)	Width (W)
	300 mm - 12"	375 mm - 15"	450 mm - 18"	525 mm - 21"	600 mm - 24"
	P/N	P/N	P/N	P/N	P/N
Vented	KFLA30	KFLA37	KFLA45	KFLA52	KFLA60
Solid	KFPA30	KFPA37	KFPA45	KFPA52	KFPA60

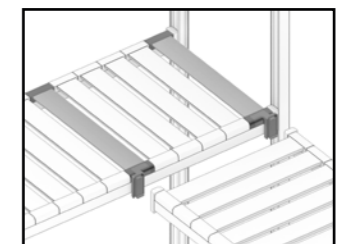

VENTED ALUMINUM SHELF RED PLASTIC SLATS

Height (H)		Load Capacity (UDL)		Width (W) 375 mm - 15"		Width (W) 600 mm - 24"	
mm	in.	kg	lbs	P/N	P/N	P/N	P/N
400	16	250	550	KFS367-RED	KFS592-RED		
475	19	250	550	KFS369-RED	KFS594-RED		
550	22	250	550	KFS371-RED	KFS596-RED		
625	25	250	550	KFS373-RED	KFS598-RED		
700	28	250	550	KFS375-RED	KFS600-RED		
775	31	250	550	KFS377-RED	KFS602-RED		
850	34	250	550	KFS379-RED	KFS604-RED		
925	37	240	530	KFS381-RED	KFS606-RED		
1000	39	240	530	KFS383-RED	KFS608-RED		
1075	42	220	485	KFS385-RED	KFS610-RED		
1150	45	220	485	KFS387-RED	KFS612-RED		
1225	48	220	485	KFS389-RED	KFS614-RED		
1300	51	200	440	KFS391-RED	KFS616-RED		
1375	54	200	440	KFS393-RED	KFS618-RED		
1450	57	200	440	KFS395-RED	KFS620-RED		
1525	60	180	400	KFS397-RED	KFS622-RED		
1600	63	180	400	KFS399-RED	KFS624-RED		
1675	66	180	400	KFS401-RED	KFS626-RED		
1750	69	150	330	KFS403-RED	KFS628-RED		
1825	72	150	330	KFS405-RED	KFS630-RED		
1900	75	120	260	KFS407-RED	KFS632-RED		
1975	78	110	240	KFS409-RED	KFS634-RED		

RED POLYETHYLENE SLATS

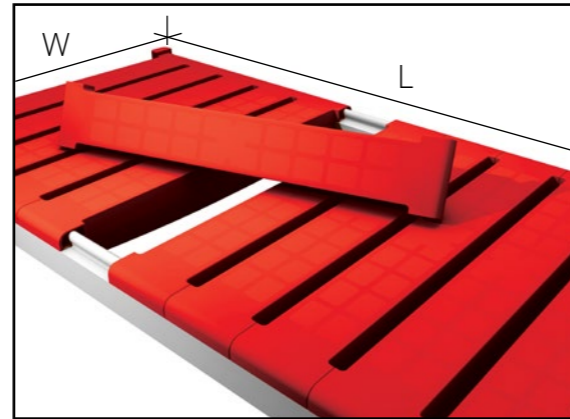

Including 4 connecting plastic clips to the frames

VENTED ALUMINUM ANTIBACTERIAL SHELF TURQUOISE PLASTIC SLATS

Height (H)		Load Capacity (UDL)		Width (W) 450 mm - 18"		Width (W) 600 mm - 24"	
mm	in.	kg	lbs	P/N	P/N	P/N	P/N
400	16	250	550	KFS442-AB	KFS592-AB		
475	19	250	550	KFS444-AB	KFS594-AB		
550	22	250	550	KFS446-AB	KFS596-AB		
625	25	250	550	KFS448-AB	KFS598-AB		
700	28	250	550	KFS450-AB	KFS600-AB		
775	31	250	550	KFS452-AB	KFS602-AB		
850	34	250	550	KFS454-AB	KFS604-AB		
925	37	240	530	KFS456-AB	KFS606-AB		
1000	39	240	530	KFS458-AB	KFS608-AB		
1075	42	220	485	KFS460-AB	KFS610-AB		
1150	45	220	485	KFS462-AB	KFS612-AB		
1225	48	220	485	KFS464-AB	KFS614-AB		
1300	51	200	440	KFS466-AB	KFS616-AB		
1375	54	200	440	KFS468-AB	KFS618-AB		
1450	57	200	440	KFS470-AB	KFS620-AB		
1525	60	180	400	KFS472-AB	KFS622-AB		
1600	63	180	400	KFS474-AB	KFS624-AB		
1675	66	180	400	KFS476-AB	KFS626-AB		
1750	69	150	330	KFS478-AB	KFS628-AB		
1825	72	150	330	KFS480-AB	KFS630-AB		
1900	75	120	260	KFS482-AB	KFS632-AB		
1975	78	110	240	KFS484-AB	KFS634-AB		

TURQUOISE POLYETHYLENE SLATS

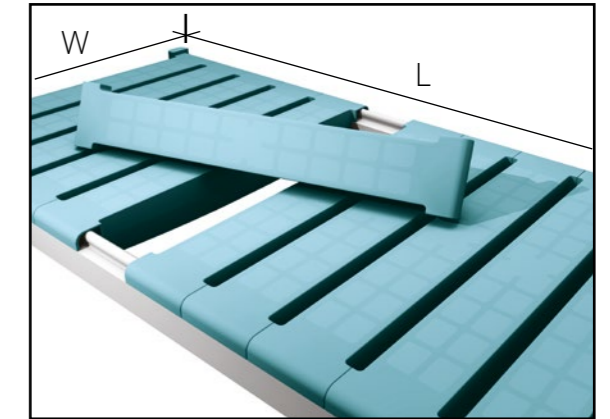

Including 4 connecting plastic clips to the frames

VENTED ALUMINUM SHELF GREEN PLASTIC SLATS

Height (H)		Load Capacity (UDL)		Width (W) 375 mm - 15"		Width (W) 600 mm - 24"	
mm	in.	kg	lbs	P/N	P/N	P/N	P/N
400	16	250	550	KFS367-GRN	KFS592-GRN		
475	19	250	550	KFS369-GRN	KFS594-GRN		
550	22	250	550	KFS371-GRN	KFS596-GRN		
625	25	250	550	KFS373-GRN	KFS598-GRN		
700	28	250	550	KFS375-GRN	KFS600-GRN		
775	31	250	550	KFS377-GRN	KFS602-GRN		
850	34	250	550	KFS379-GRN	KFS604-GRN		
925	37	240	530	KFS381-GRN	KFS606-GRN		
1000	39	240	530	KFS383-GRN	KFS608-GRN		
1075	42	220	485	KFS385-GRN	KFS610-GRN		
1150	45	220	485	KFS387-GRN	KFS612-GRN		
1225	48	220	485	KFS389-GRN	KFS614-GRN		
1300	51	200	440	KFS391-GRN	KFS616-GRN		
1375	54	200	440	KFS393-GRN	KFS618-GRN		
1450	57	200	440	KFS395-GRN	KFS620-GRN		
1525	60	180	400	KFS397-GRN	KFS622-GRN		
1600	63	180	400	KFS399-GRN	KFS624-GRN		
1675	66	180	400	KFS401-GRN	KFS626-GRN		
1750	69	150	330	KFS403-GRN	KFS628-GRN		
1825	72	150	330	KFS405-GRN	KFS630-GRN		
1900	75	120	260	KFS407-GRN	KFS632-GRN		
1975	78	110	240	KFS409-GRN	KFS634-GRN		

GREEN POLYETHYLENE SLATS

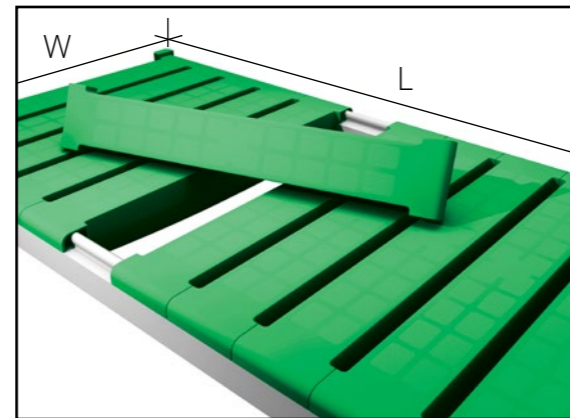

Including 4 connecting plastic clips to the frames

SHELF POLYETHYLENE SLATS FOR DISPLAY SHELVING

Length (L)		Load Capacity (UDL)		Width (W) 600 mm - 24"		Description
mm	in.	kg	lbs	P/N		
400	16	250	550	KFD592		Display shelf with fall arresting bar 24"x 16" (600x400 mm)
475	19	250	550	KFD594		Display shelf with fall arresting bar 24"x 19" (600x475 mm)
550	22	250	550	KFD596		Display shelf with fall arresting bar 24"x 22" (600x550 mm)
625	25	250	550	KFD598		Display shelf with fall arresting bar 24"x 25" (600x625 mm)
700	28	250	550	KFD600		Display shelf with fall arresting bar 24"x 28" (600x700 mm)
775	31	250	550	KFD602		Display shelf with fall arresting bar 24"x 31" (600x775 mm)
850	34	250	550	KFD604		Display shelf with fall arresting bar 24"x 34" (600x850 mm)
925	37	240	530	KFD606		Display shelf with fall arresting bar 24"x 37" (600x925 mm)
1000	39	240	530	KFD608		Display shelf with fall arresting bar 24"x 39" (600x1000 mm)
1075	42	220	485	KFD610		Display shelf with fall arresting bar 24"x 42" (600x1025 mm)
1150	45	220	485	KFD612		Display shelf with fall arresting bar 24"x 45" (600x1150 mm)
1225	48	220	485	KFD614		Display shelf with fall arresting bar 24"x 48" (600x1225 mm)
1300	51	200	440	KFD616		Display shelf with fall arresting bar 24"x51" (600x1300 mm)
1375	54	200	440	KFD618		Display shelf with fall arresting bar 24"x54" (600x1375 mm)
1450	57	200	440	KFD620		Display shelf with fall arresting bar 24"x57" (600x1450 mm)
1525	60	180	400	KFD622		Display shelf with fall arresting bar 24"x60" (600x1525 mm)
1600	63	180	400	KFD624		Display shelf with fall arresting bar 24"x63" (600x1600 mm)
1675	66	180	400	KFD626		Display shelf with fall arresting bar 24"x66" (600x1675 mm)

LIGHT GRAY POLYETHYLENE SLATS

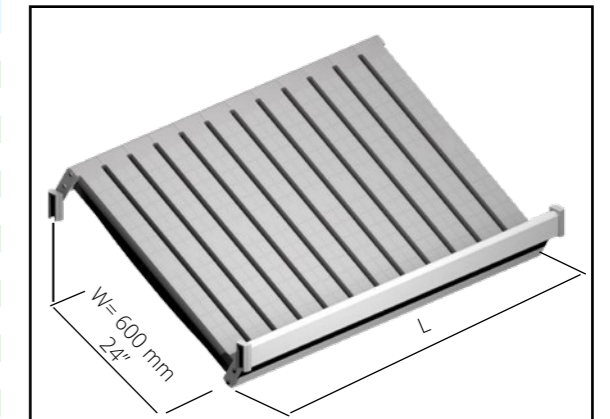

Including 4 connecting plastic clips to the frames

CENTRAL ALUMINUM INTEGRATION FRAME

Height (H)		Load Capacity (UDL)		Width (W) 150 mm - 6"		Width (W) 225 mm - 9"		Width (W) 300 mm - 12"	
mm	in.	kg	lbs	P/N	P/N	P/N	P/N	P/N	
950	37	1000	2200	KIS091	KIS092	KIS093			
1250	49	1000	2200	KIS121	KIS122	KIS123			
1550	61	1000	2200	KIS151	KIS152	KIS153			
1700	67	1000	2200	KIS171	KIS172	KIS173			
1850	73	1000	2200	KIS181	KIS182	KIS183			
2000	79	1000	2200	KIS201	KIS202	KIS203			
2150	85	1000	2200	KIS211	KIS212	KIS213			
2450	96	1000	2200	KIS241	KIS242	KIS243			

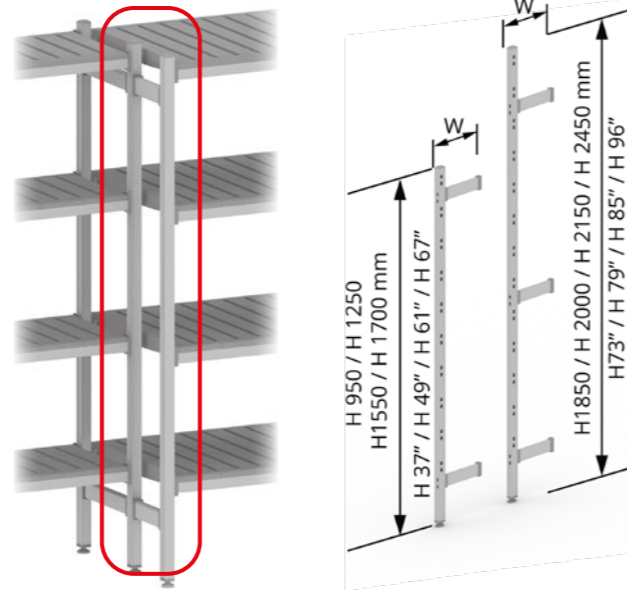

Complete with adjustable base, cap and matching frame brackets

Width 150 mm / +6"

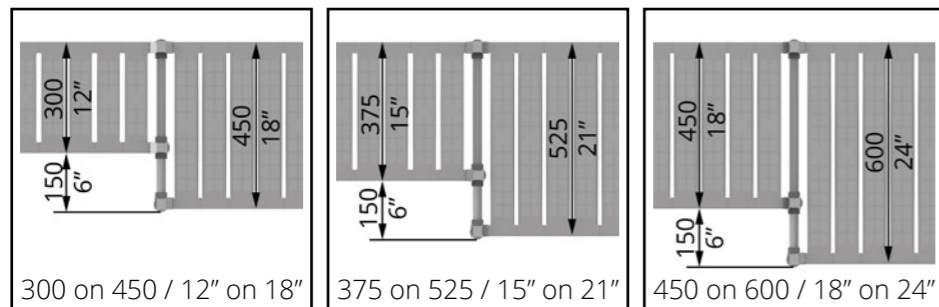

Width +225 mm / +9"

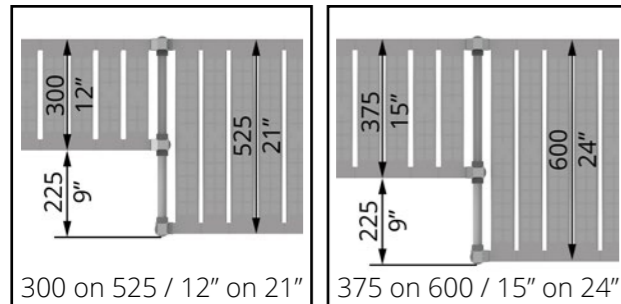

Width +300 mm / +12"

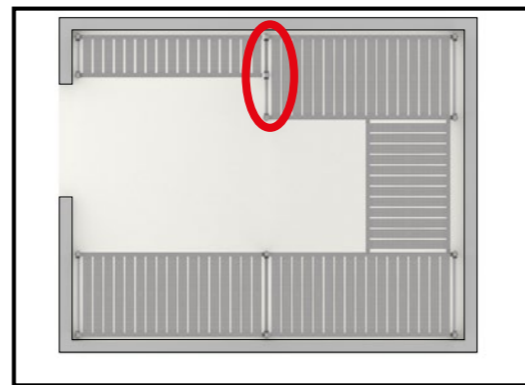
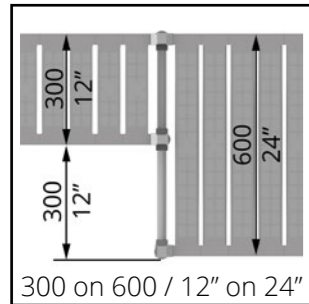

Example of coldroom composition

ALUMINUM TERMINAL FRAME WITH SIDE PANEL

Height (H)		Load Capacity (UDL)		Width (W) 300 mm - 12"		Width (W) 375 mm - 15"		Width (W) 450 mm - 18"		Width (W) 525 mm - 21"		Width (W) 600 mm - 24"	
mm	in.	kg	lbs	P/N	P/N	P/N	P/N	P/N	P/N	P/N	P/N	P/N	
950	37	1000	2200	KTC290	KTC365	KTC440	KTC515	KTC590					
1250	49	1000	2200	KTC294	KTC369	KTC444	KTC519	KTC594					
1550	61	1000	2200	KTC298	KTC373	KTC448	KTC523	KTC598					
1700	67	1000	2200	KTC300	KTC375	KTC450	KTC525	KTC600					
1850	73	1000	2200	KTC301	KTC376	KTC451	KTC526	KTC601					
2000	79	1000	2200	KTC302	KTC377	KTC452	KTC527	KTC602					
2150	85	1000	2200	KTC303	KTC378	KTC453	KTC528	KTC603					
2450	96	1000	2200	KTC304	KTC379	KTC454	KTC529	KTC604					

ALUMINUM CENTRAL FRAME WITH SIDE PANEL

Height (H)		Load Capacity (UDL)		Width (W) 300 mm - 12"		Width (W) 375 mm - 15"		Width (W) 450 mm - 18"		Width (W) 525 mm - 21"		Width (W) 600 mm - 24"	
mm	in.	kg	lbs	P/N	P/N	P/N	P/N	P/N	P/N	P/N	P/N	P/N	
950	37	1000	2200	KCC290	KCC365	KCC440	KCC515	KCC590					
1250	49	1000	2200	KCC294	KCC369	KCC444	KCC519	KCC594					
1550	61	1000	2200	KCC298	KCC373	KCC448	KCC523	KCC598					
1700	67	1000	2200	KCC300	KCC375	KCC450	KCC525	KCC600					
1850	73	1000	2200	KCC301	KCC376	KCC451	KCC526	KCC601					
2000	79	1000	2200	KCC302	KCC377	KCC452	KCC527	KCC602					
2150	85	1000	2200	KCC303	KCC378	KCC453	KCC528	KCC603					
2450	96	1000	2200	KCC304	KCC379	KCC454	KCC529	KCC604					

Version valid for
H 950 / 1250 / 1550 / 1700 mm
H 37" / 49" / 61" / 67"

Version valid for
H 1850 / 2000 / 2150 mm
H 73" / 79" / 85"

Version valid for
H 2450 mm
H 96"



STANDARD* panel color range

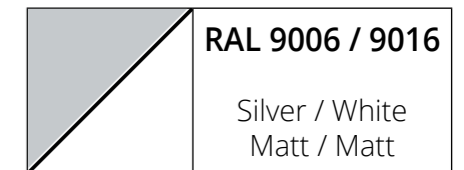

*possible special colors upon request

Complete with adjustable base, cap and side panel

INNER UPRIGHTS HANGING BARS

Length (L)		P/N	Length (L)		P/N
mm	in.		mm	in.	
400	16	KFG004	1225	48	KFG015
475	19	KFG005	1300	51	KFG016
550	22	KFG006	1375	54	KFG017
625	25	KFG007	1450	57	KFG018
700	28	KFG008	1525	60	KFG019
775	31	KFG009	1600	63	KFG020
850	34	KFG010	1675	66	KFG021
925	37	KFG011	1750	69	KFG022
1000	39	KFG012	1825	72	KFG023
1075	42	KFG013	1900	75	KFG024
1150	45	KFG014	1975	78	KFG025

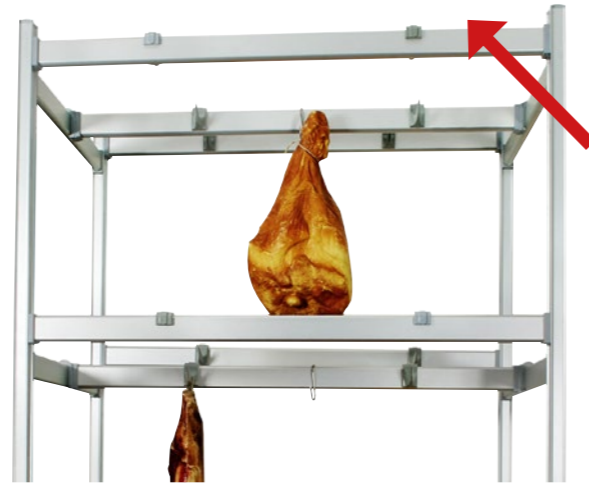

INNER FRAMES HANGING BARS

Length (L)		P/N	Length (L)		P/N
mm	in.		mm	in.	
400	16	KFGL04	1225	48	KFGL15
475	19	KFGL05	1300	51	KFGL16
550	22	KFGL06	1375	54	KFGL17
625	25	KFGL07	1450	57	KFGL18
700	28	KFGL08	1525	60	KFGL19
775	31	KFGL09	1600	63	KFGL20
850	34	KFGL10	1675	66	KFGL21
925	37	KFGL11	1750	69	KFGL22
1000	39	KFGL12	1825	72	KFGL23
1075	42	KFGL13	1900	75	KFGL24
1150	45	KFGL14	1975	78	KFGL25

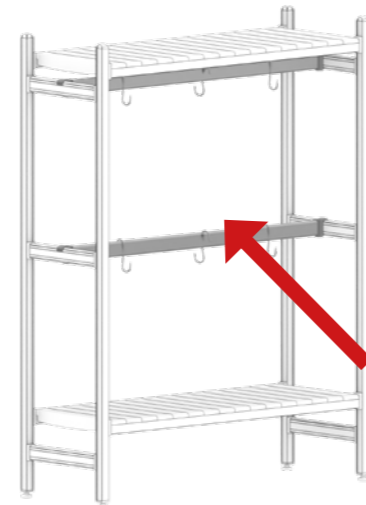

"S" SHAPED HOOK

P/N	Description
SPX313	"S" shaped stainless steel hook H 6¼" (160 mm), Ø¼" (6 mm), for hanging bars



POLYETHYLENE HOOK

P/N	Description
SPX300	Polyethylene hook, 110 lbs (50 kg) load capacity, for hanging bars

LONGITUDINAL FALL ARRESTING HEAVY DUTY BAR

Length(L)		P/N	Length(L)		P/N
mm	in.		mm	in.	
400	16	KFG004	1225	48	KFG015
475	19	KFG005	1300	51	KFG016
550	22	KFG006	1375	54	KFG017
625	25	KFG007	1450	57	KFG018
700	28	KFG008	1525	60	KFG019
775	31	KFG009	1600	63	KFG020
850	34	KFG010	1675	66	KFG021
925	37	KFG011	1750	69	KFG022
1000	39	KFG012	1825	72	KFG023
1075	42	KFG013	1900	75	KFG024
1150	45	KFG014	1975	78	KFG025



LONGITUDINAL FALL ARRESTING QUICK RELEASE BAR

Length(L)		P/N	Length(L)		P/N
mm	in.		mm	in.	
400	16	KFGR04	1225	48	KFGR15
475	19	KFGR05	1300	51	KFGR16
550	22	KFGR06	1375	54	KFGR17
625	25	KFGR07	1450	57	KFGR18
700	28	KFGR08	1525	60	KFGR19
775	31	KFGR09	1600	63	KFGR20
850	34	KFGR10	1675	66	KFGR21
925	37	KFGR11	1750	69	KFGR22
1000	39	KFGR12	1825	72	KFGR23
1075	42	KFGR13	1900	75	KFGR24
1150	45	KFGR14	1975	78	KFGR25



LONGITUDINAL FALL ARRESTING LIGHT BAR

Length(L)		P/N	Length (L)		P/N
mm	in.		in.	mm	
400	16	KFGT04	1000	39	KFGT12
475	19	KFGT05	1075	42	KFGT13
550	22	KFGT06	1150	45	KFGT14
625	25	KFGT07	1225	48	KFGT15
700	28	KFGT08	1300	51	KFGT16
775	31	KFGT09	1375	54	KFGT17
850	34	KFGT10	1450	57	KFGT18
925	37	KFGT11	1525	60	KFGT19

For lengths above 60" (1525 mm) we'll use the other fall arresting bar



TRANSVERSAL FALL ARRESTING HEAVY DUTY BAR

Width (W)	300 mm - 12"	375 mm - 15"	450 mm - 18"	525 mm - 21"	600 mm - 24"
P/N	KFG300	KFG375	KFG450	KFG525	KFG600

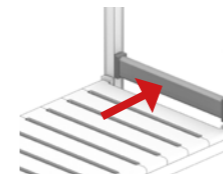

TRANSVERSAL FALL ARRESTING LIGHT BAR

Width (W)	300 mm - 12"	375 mm - 15"	450 mm - 18"	525 mm - 21"	600 mm - 24"
P/N	KFGT30	KFGT37	KFGT45	KFGT52	KFGT60

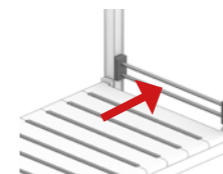

BACK FALL ARRESTING BARS

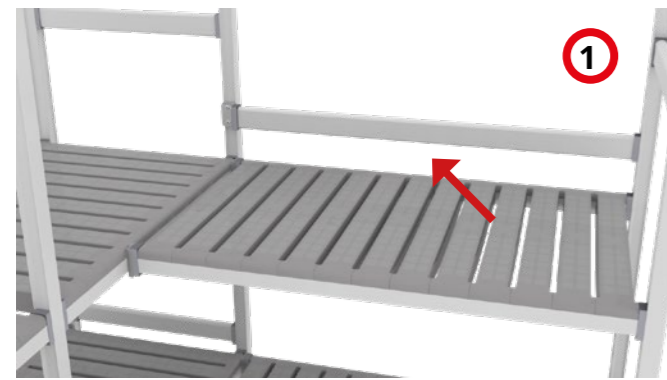

FALL ARRESTING BAR, RIGHT CORNER

Length(L)		P/N	Length(L)		P/N
mm	in.		mm	in.	
400	16	KFG004-LDX-P	1225	48	KFG015-LDX-P
475	19	KFG005-LDX-P	1300	51	KFG016-LDX-P
550	22	KFG006-LDX-P	1375	54	KFG017-LDX-P
625	25	KFG007-LDX-P	1450	57	KFG018-LDX-P
700	28	KFG008-LDX-P	1525	60	KFG019-LDX-P
775	31	KFG009-LDX-P	1600	63	KFG020-LDX-P
850	34	KFG010-LDX-P	1675	66	KFG021-LDX-P
925	37	KFG011-LDX-P	1750	69	KFG022-LDX-P
1000	39	KFG012-LDX-P	1825	72	KFG023-LDX-P
1075	42	KFG013-LDX-P	1900	75	KFG024-LDX-P
1150	45	KFG014-LDX-P	1975	78	KFG025-LDX-P

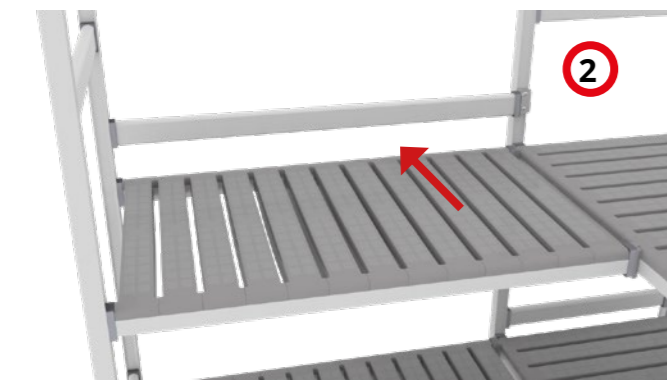

FALL ARRESTING BAR, LEFT CORNER

Length(L)		P/N	Length(L)		P/N
mm	in.		mm	in.	
400	16	KFG004-LSX-P	1225	48	KFG015-LSX-P
475	19	KFG005-LSX-P	1300	51	KFG016-LSX-P
550	22	KFG006-LSX-P	1375	54	KFG017-LSX-P
625	25	KFG007-LSX-P	1450	57	KFG018-LSX-P
700	28	KFG008-LSX-P	1525	60	KFG019-LSX-P
775	31	KFG009-LSX-P	1600	63	KFG020-LSX-P
850	34	KFG010-LSX-P	1675	66	KFG021-LSX-P
925	37	KFG011-LSX-P	1750	69	KFG022-LSX-P
1000	39	KFG012-LSX-P	1825	72	KFG023-LSX-P
1075	42	KFG013-LSX-P	1900	75	KFG024-LSX-P
1150	45	KFG014-LSX-P	1975	78	KFG025-LSX-P

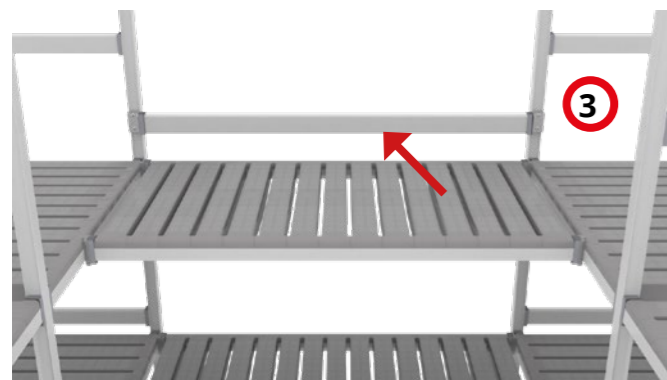

FALL ARRESTING BAR, "U" SHAPE

Length(L)		P/N	Length(L)		P/N
mm	in.		mm	in.	
400	16	KFG004-U-P	1225	48	KFG015-U-P
475	19	KFG005-U-P	1300	51	KFG016-U-P
550	22	KFG006-U-P	1375	54	KFG017-U-P
625	25	KFG007-U-P	1450	57	KFG018-U-P
700	28	KFG008-U-P	1525	60	KFG019-U-P
775	31	KFG009-U-P	1600	63	KFG020-U-P
850	34	KFG010-U-P	1675	66	KFG021-U-P
925	37	KFG011-U-P	1750	69	KFG022-U-P
1000	39	KFG012-U-P	1825	72	KFG023-U-P
1075	42	KFG013-U-P	1900	75	KFG024-U-P
1150	45	KFG014-U-P	1975	78	KFG025-U-P

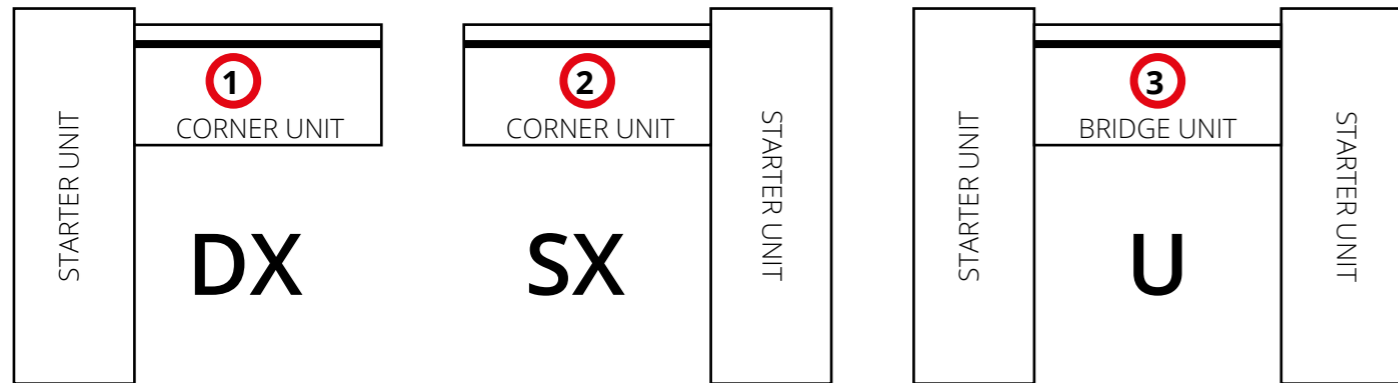

FRONT FALL ARRESTING BARS

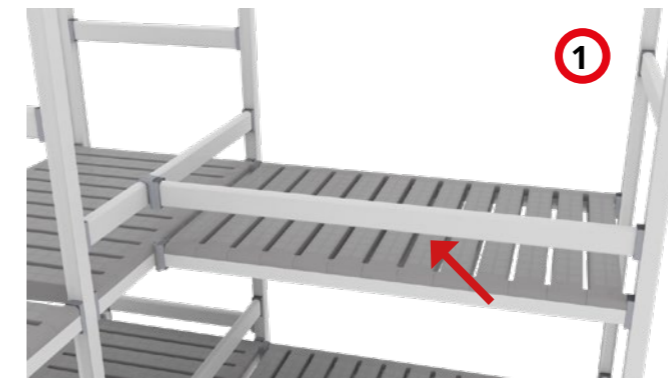

FALL ARRESTING BAR, RIGHT CORNER

Length(L)		P/N	Length(L)		P/N
mm	in.		mm	in.	
400	16	KFG004-LDX-A	1225	48	KFG015-LDX-A
475	19	KFG005-LDX-A	1300	51	KFG016-LDX-A
550	22	KFG006-LDX-A	1375	54	KFG017-LDX-A
625	25	KFG007-LDX-A	1450	57	KFG018-LDX-A
700	28	KFG008-LDX-A	1525	60	KFG019-LDX-A
775	31	KFG009-LDX-A	1600	63	KFG020-LDX-P
850	34	KFG010-LDX-A	1675	66	KFG021-LDX-A
925	37	KFG011-LDX-A	1750	69	KFG022-LDX-A
1000	39	KFG012-LDX-A	1825	72	KFG023-LDX-A
1075	42	KFG013-LDX-A	1900	75	KFG024-LDX-A
1150	45	KFG014-LDX-A	1975	78	KFG025-LDX-A

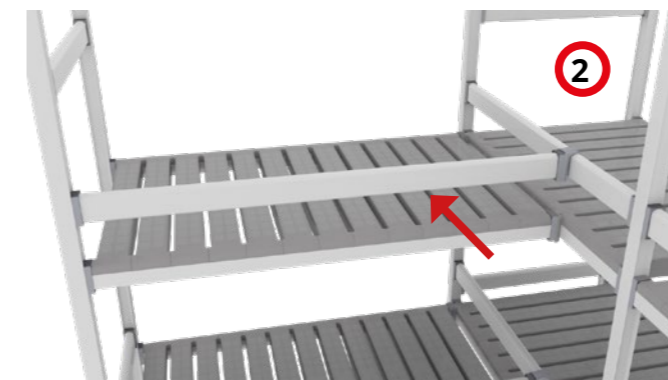

FALL ARRESTING BAR, LEFT CORNER

Length(L)		P/N	Length(L)		P/N
mm	in.		mm	in.	
400	16	KFG004-LSX-A	1225	48	KFG015-LSX-A
475	19	KFG005-LSX-A	1300	51	KFG016-LSX-A
550	22	KFG006-LSX-A	1375	54	KFG017-LSX-A
625	25	KFG007-LSX-A	1450	57	KFG018-LSX-A
700	28	KFG008-LSX-A	1525	60	KFG019-LSX-A
775	31	KFG009-LSX-A	1600	63	KFG020-LSX-A
850	34	KFG010-LSX-A	1675	66	KFG021-LSX-A
925	37	KFG011-LSX-A	1750	69	KFG022-LSX-A
1000	39	KFG012-LSX-A	1825	72	KFG023-LSX-A
1075	42	KFG013-LSX-A	1900	75	KFG024-LSX-A
1150	45	KFG014-LSX-A	1975	78	KFG025-LSX-A

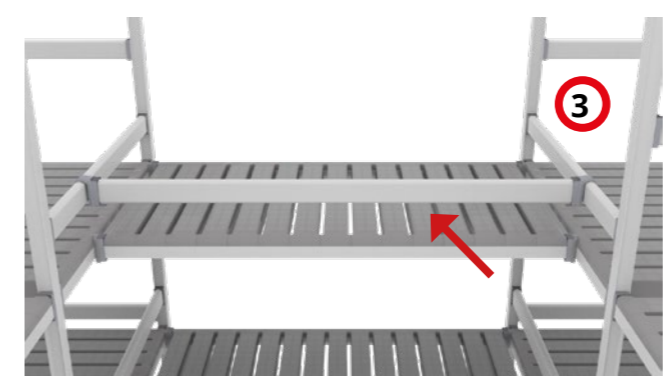

FALL ARRESTING BAR, "U" SHAPE

Length(L)		P/N	Length(L)		P/N
mm	in.		mm	in.	
400	16	KFG004-U-A	1225	48	KFG015-U-A
475	19	KFG005-U-A	1300	51	KFG016-U-A
550	22	KFG006-U-A	1375	54	KFG017-U-A
625	25	KFG007-U-A	1450	57	KFG018-U-A
700	28	KFG008-U-A	1525	60	KFG019-U-A
775	31	KFG009-U-A	1600	63	KFG020-U-A
850	34	KFG010-U-A	1675	66	KFG021-U-A
925	37	KFG011-U-A	1750	69	KFG022-U-A
1000	39	KFG012-U-A	1825	72	KFG023-U-A
1075	42	KFG013-U-A	1900	75	KFG024-U-A
1150	45	KFG014-U-A	1975	78	KFG025-U-A

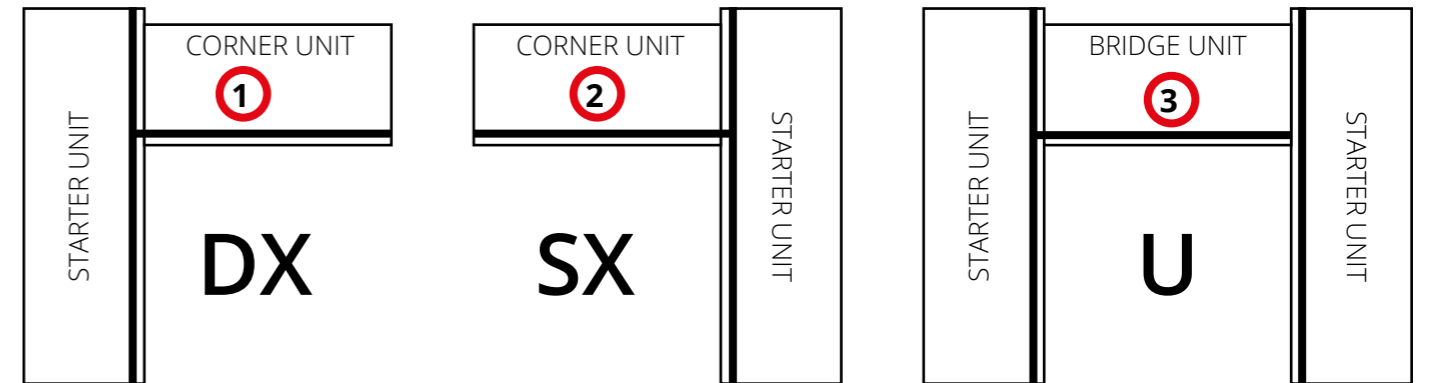

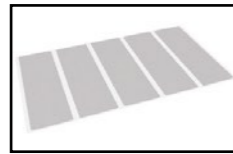

SEALING HOLES STICKY LABELS

P/N	Description
KFSET2	5 sealing holes sticky labels (pack of 10 pcs)



DUNNAGE STAND

Width mm (W)	300 mm - 12"	375 mm - 15"	450 mm - 18"	525 mm - 21"	600 mm - 24"
P/N	KFRR30	KFRR37	KFRR45	KFRR52	KFRR60

Only with shelf H 320 mm from the ground

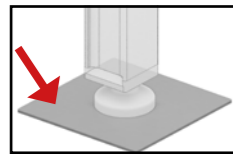

WEIGHT DISTRIBUTION PLATE

P/N	Description
KFSRC2	Weight distribution plate on floors 100 x 100 x H 4 mm

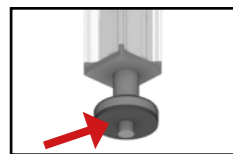

ADJUSTABLE BASE WITH FLOOR / CEILING PIN

P/N	Description
KFBPS2	Adjustable base with floor or ceiling pin (rubber gasket included)



SPECIAL STAINLESS STEEL BASE FOR MARITIME SOLUTIONS

P/N	Description
KFSEA1	Special stainless steel base for maritime solutions (rubber gasket included)

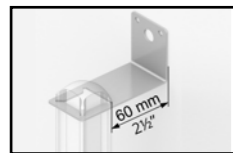

FIXING FRAMES TO THE WALLS

P/N	Description
KFS-FP2	Stainless steel bracket for fixing frames to the wall (nuts and bolts not included)

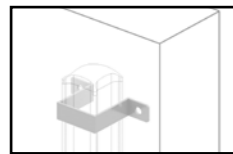

WALL MOUNT CLAMP OMEGA FOR FRAMES

P/N	Description
KFS-FP4	Wall mount clamp omega for frames (hardware not included)



ADJUSTABLE WALL MOUNT FOR FRAMES

P/N	Description
KFS-FP6	Adjustable wall mount (25-50 mm) for frames

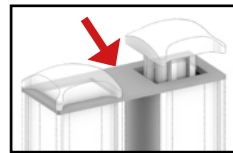

MATCHING FRAMES BRACKET

P/N	Description
KFS-AS2	Stainless steel matching frame bracket (matched towards depth)

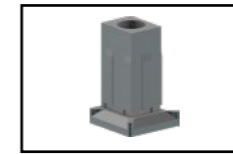

WHEEL KIT WITH BRAKES

P/N	Description
KTRT55	Kit to accommodate caster wheel P/N RTSCF5



RESIN ROTATING WHEEL WITH BRAKE

P/N	Description
RTSCF5	Resin rotating caster wheel Ø 125 mm (5") with brake. (Always combined with P/N KTRT55)

The shelving system increases its height of 135 mm (5¼") by adding the wheel kit and the rotating wheel. Total max load capacity is 125 kg (275 lbs).

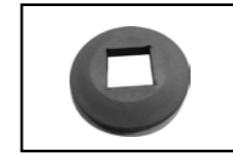

BUMPER Ø 95 MM (3¾")

P/N	Description
PCSCF5	Rubber bumper Ø 95 mm (3¾") (optional)

By adding of the bumper the shelf width increases by 60 mm - 2½"



HANGING SLATS

Shelf type	Width mm (W)				
	300 mm 12"	375 mm 15"	450 mm 18"	525 mm 21"	600 mm 24"
POLYETHYLENE					
VENTED ALUMINUM	KFEB30	KFEB37	KFEB45	KFEB52	KFEB60
SOLID ALUMINUM					



"S" SHAPED STAINLESS STEEL HOOK

P/N	Description
SPX313	"S" shaped stainless steel hook H 160 mm (6¼"), Ø 6 mm (¼"), for hanging bars



SECURITY CAGE

P/N	Description
KFGD55	Stainless steel security cage 920 x 600x H 390 mm (36¼" x 24" x H 15½") - Lock not included



TRAYS HOLDER

P/N	Description
KFMPV5	Aluminum / Stainless steel GN trays holder 410 x 600x H 390 mm (15¾" x 24" x H 15")



FOODPANS GASTRONORM KIT

Shelf type	Width mm (W)				
	300 mm 12"	375 mm 15"	450 mm 18"	525 mm 21"	600 mm 24"
POLYETHYLENE					
VENTED ALUMINUM	NOT AVAILABLE	KFGS37	NOT AVAILABLE	NOT AVAILABLE	NOT AVAILABLE
SOLID ALUMINUM					

As per food safety requirements, nothing should be stored on the floor for easy cleaning. Benches are the perfect solution to this need. Benches, like our shelving, are modular and they come as combination of pair of frames and plastic shelf.

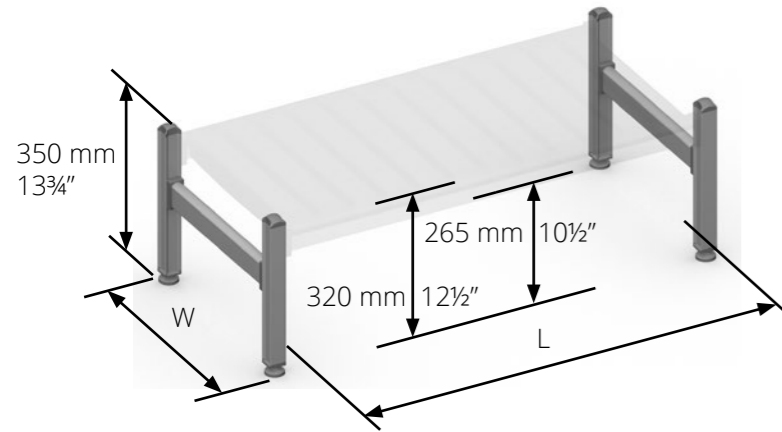

PAIR OF FRAMES FOR ALUMINUM BENCHES

Height tot 350 mm 13 3/4"	Width mm (W)				
	300 mm 12"	375 mm 15"	450 mm 18"	525 mm 21"	600 mm 24"
P/N	KFB300	KFB375	KFB450	KFB525	KFB600

VENTED ALUMINUM SHELF WITH PLASTIC SLATS

Length (L)	Load Capacity (UDL)	Width (W)						
		300 mm - 12"	375 mm - 15"	450 mm - 18"	525 mm - 21"	600 mm - 24"		
mm	in.	kg	lbs	P/N	P/N	P/N	P/N	P/N
400	16	250	550	KFS292	KFS367	KFS442	KFS517	KFS592
475	19	250	550	KFS294	KFS369	KFS444	KFS519	KFS594
550	22	250	550	KFS296	KFS371	KFS446	KFS521	KFS596
625	25	250	550	KFS298	KFS373	KFS448	KFS523	KFS598
700	28	250	550	KFS300	KFS375	KFS450	KFS525	KFS600
775	31	250	550	KFS302	KFS377	KFS452	KFS527	KFS602
850	34	250	550	KFS304	KFS379	KFS454	KFS529	KFS604
925	37	240	530	KFS306	KFS381	KFS456	KFS531	KFS606
1000	39	240	530	KFS308	KFS383	KFS458	KFS533	KFS608
1075	42	220	485	KFS310	KFS385	KFS460	KFS535	KFS610
1150	45	220	485	KFS312	KFS387	KFS462	KFS537	KFS612
1225	48	220	485	KFS314	KFS389	KFS464	KFS539	KFS614
1300	51	200	440	KFS316	KFS391	KFS466	KFS541	KFS616
1375	54	200	440	KFS318	KFS393	KFS468	KFS543	KFS618
1450	57	200	440	KFS320	KFS395	KFS470	KFS545	KFS620
1525	60	180	400	KFS322	KFS397	KFS472	KFS547	KFS622
1600	63	180	400	KFS324	KFS399	KFS474	KFS549	KFS624
1675	66	180	400	KFS326	KFS401	KFS476	KFS551	KFS626
1750	69	150	330	KFS328	KFS403	KFS478	KFS553	KFS628
1825	72	150	330	KFS330	KFS405	KFS480	KFS555	KFS630
1900	75	120	260	KFS332	KFS407	KFS482	KFS557	KFS632
1975	78	110	240	KFS334	KFS409	KFS484	KFS559	KFS634

For different types of shelves please go to page 22.

LIGHT GRAY
POLYETHYLENE SLATS

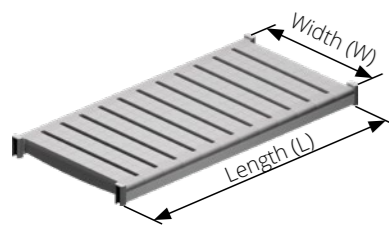

Including 4 connecting
plastic clips to the frames



DUNNAGE STAND

Width mm	300 mm 12"	375 mm 15"	450 mm 18"	525 mm 21"	600 mm 24"
P/N	KFRR30	KFRR37	KFRR45	KFRR52	KFRR60

Suggested for lengths bigger than 1225 mm (48")

LABEL HOLDERS

The rail, with its linear design, fits all shelf lengths. It is available exclusively when ordering shelving.

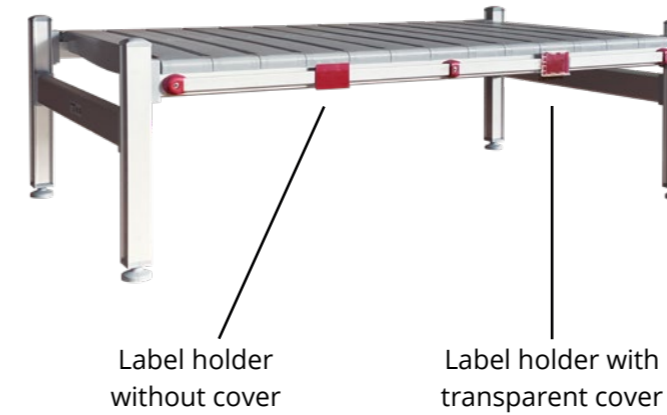

P/N	Description
LHPROF-0475	Horizontal label holder bar L 475 mm - 19"
LHPROF-0550	Horizontal label holder bar L 550 mm - 22"
LHPROF-0625	Horizontal label holder bar L 625 mm - 25"
LHPROF-0700	Horizontal label holder bar L 700 mm - 28"
LHPROF-0775	Horizontal label holder bar L 775mm - 31"
LHPROF-0850	Horizontal label holder bar L 850 mm - 34"
LHPROF-0925	Horizontal label holder bar L 925 mm - 37"
LHPROF-1000	Horizontal label holder bar L 1000 mm - 39"
LHPROF-1075	Horizontal label holder bar L 1075 mm - 42"
LHPROF-1150	Horizontal label holder bar L 1150 mm - 45"
LHPROF-1225	Horizontal label holder bar L 1225 mm - 48"
LHPROF-1300	Horizontal label holder bar L 1300 mm - 51"
LHPROF-1375	Horizontal label holder bar L 1375 mm - 54"
LHPROF-1450	Horizontal label holder bar L 1450 mm - 57"
LHPROF-1525	Horizontal label holder bar L 1525 mm - 60"
LHPROF-1600	Horizontal label holder bar L 1600 mm - 63"
LHPROF-1675	Horizontal label holder bar L 1675 mm - 66"
LHPROF-1750	Horizontal label holder bar L 1750 mm - 69"
LHPROF-1825	Horizontal label holder bar L 1825 mm - 72"
LHPROF-1900	Horizontal label holder bar L 1900 mm - 75"
LHPROF-1975	Horizontal label holder bar L 1975 mm - 78"
LBLHLD	Label holder 57x40 mm - 2" x 1"
LBL-HORZCOV	Transparent cover for label holder

SHELF DIVIDERS

Available for all 5 shelf depths. Label holders with and without covers can be attached to the dividers.



Width (W)	P/N
300 mm 12"	DIV-300
375 mm 15"	DIV-375
450 mm 18"	DIV-450
525 mm 21"	DIV-525
600 mm 24"	DIV-600

WALL MOUNTED SHELVES

The wall mounted shelf allows you to use space that would otherwise go unused. Shelf depths are 300 mm or 375 mm, and lengths range from 400 mm up to 1225 mm (see table from page 22). The shelf is available with gray polyethylene or aluminum slats. Its maximum load capacity is 50 kg (110 lbs).

PAIR OF TERMINAL WALL SUPPORT

Width (W)	300 mm - 12"	375 mm - 15"
P/N	MFB300	MFB375

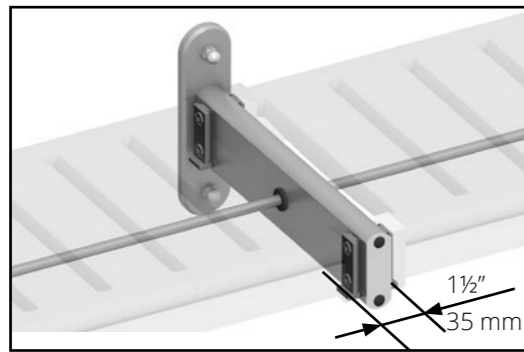
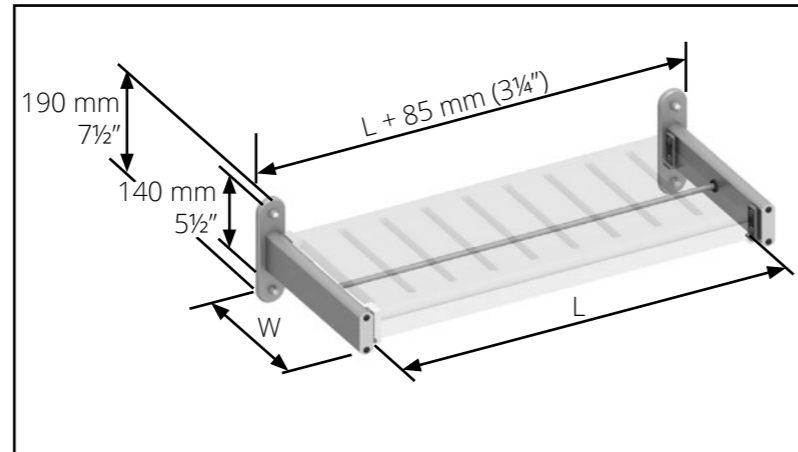

SINGLE CENTRAL WALL SUPPORT

Width (W)	300 mm - 12"	375 mm - 15"
P/N	MFC300	MFC375



SHELVING KIT



Made of 2 frames and 4 shelves. Overall dimensions are 995 x 375/450 x H1700 mm (39" x 15"/18" x H73") Shelves pitch is fixed.

SHELVING KIT

P/N	Dimensions
FS3714	995 x 375 x H1700 mm - 39" x 15" x 67"
FS4514	995 x 450 x H1700 mm - 39" x 18" x 67"

Load capacity 240 kg (530 lbs) each tier

Max load capacity 960 kg (2115 lbs)

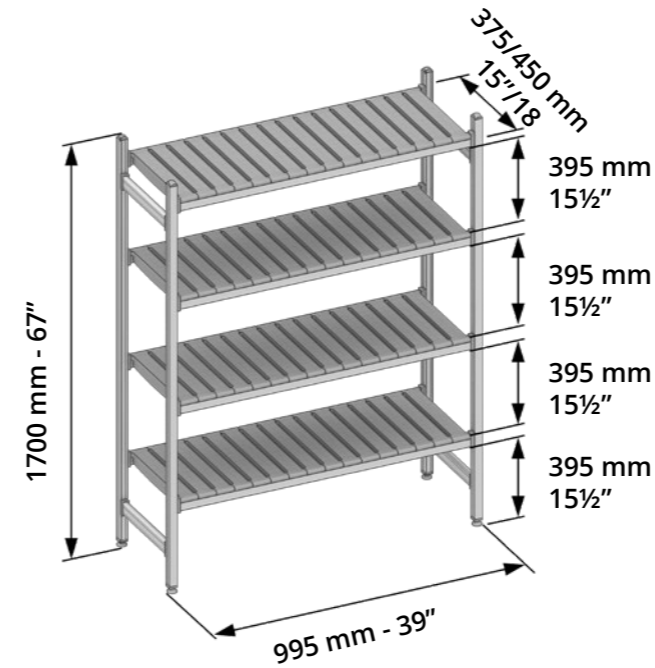

Removable slats



Adjustable bases

12 / 18 pieces each pallet

Weight: 16 / 18 kg cad
35 / 40 lbs cad





SHELVING WITH RAILS TOP Series

Available in a single height of 2000 mm, the "L" Rail Shelving is the ideal solution for optimizing the storage of Gastronorm foodpan, ISO 6040 boxes and industrial dishwasher baskets.

The three span types, can be combined with each other or with our TOP Series shelves to create continuous linear shelving.

The rails of these frames have a fixed position and are supplied already assembled.



Shelving with L-shaped rails for Gastronorm foodpanS
325x525 mm - 12" x 20"
(12 positions)



Shelving with L-shaped rails for ISO 6040 boxes
400x600 mm - 15" x 23"
(7 positions)



Shelving with L-shaped rails for industrial dishwasher baskets
500x500 mm - 19" x 19"
(9 positions)

FRAME WITH L-SHAPED RAILS

Description	P/N	Height (H)	Width (W)	Description	P/N	Height (H)	Width (W)
CENTRAL FRAME 2000 x 600 mm 78" x 24" 7 + 7 rails	KFC602-L07/L07	2000 mm 78"	600 mm 24"	CENTRAL FRAME 2000 x 600 mm 78" x 24" 7 + 9 rails	KFC602-L07/L09	2000 mm 78"	600 mm 24"

Description	P/N	Height (H)	Width (W)	Description	P/N	Height (H)	Width (W)
CENTRAL FRAME 2000 x 600 mm 78" x 24" 7 + 12 rails	KFC602-L07/L12	2000 mm 78"	600 mm 24"	CENTRAL FRAME 2000 x 600 mm 78" x 24" 7 rails + shelves	KFC602-L07/SHELF	2000 mm 78"	600 mm 24"
CENTRAL FRAME 2000 x 600 mm 78" x 24" 9 + 9 rails	KFC602-L09/L09	2000 mm 78"	600 mm 24"	CENTRAL FRAME 2000 x 600 mm 78" x 24" 9 rails + shelves	KFC602-L09/SHELF	2000 mm 78"	600 mm 24"
CENTRAL FRAME 2000 x 600 mm 78" x 24" 9 + 12 rails	KFC602-L09/L12	2000 mm 78"	600 mm 24"	CENTRAL FRAME 2000 x 600 mm 78" x 24" 12 + 12 rails	KFC602-L12/L12	2000 mm 78"	600 mm 24"
CENTRAL FRAME 2000 x 600 mm 78" x 24" 12 rails + shelves	KFC602-L12/SHELF	2000 mm 78"	600 mm 24"	TERMINAL FRAME 2000 x 600 mm 78" x 24" 7 rails	KFT602-L07	2000 mm 78"	600 mm 24"

Description	P/N	Height (H)	Width (W)	Description	P/N	Height (H)	Width (W)
TERMINAL FRAME 2000 x 600 mm 78" x 24" 9 rails	KFT602-L09	2000 mm 78"	600 mm 24"	TERMINAL FRAME 2000 x 600 mm 78" x 24" 12 rails	KFT602-L12	2000 mm 78"	600 mm 24"

SET 4 FRONT CROSSBARS

Description	P/N	Length
SET 4 FRONT CROSSBARS FOR SHELVING DISHWASHER BASKETS	S2CL-DCSUPPL-DWS	521mm 20"
SET 4 FRONT CROSSBARS FOR SHELVING GASTRONORM FOODPANS	S2CL-DCSUPPL-GN1	361 mm 14"
SET 4 FRONT CROSSBARS FOR SHELVING ISO 6040 BOXES	S2CL-DCSUPPL-ISO	415 mm 16"

DUST COVER (ACCESSORY)

Description	P/N
DUST COVER FOR SHELVING ISO 6040 BOXES	TOP-DC-ISO
DUST COVER FOR SHELVING GASTRONORM FOODPANS	TOP-DC-GN1
DUST COVER FOR SHELVING DISHWASHER BASKETS	TOP-DC-DWS



These shelvings for Gastronorm foodpans are equipped with movable rails that allow you to choose the position desired for storing containers of even different sizes. The structure is available in three different heights (1880, 2000 and 2120 mm - 74", 79" and 83") and the rails have a minimum distance from each other of 120 mm.



Shelving for Gastronorm foodpans
H 1880 mm - 74"
(maximum 12 positions)

Shelving for Gastronorm foodpans
H 2000 mm - 79"
(maximum 13 positions)

Shelving for Gastronorm foodpans
H 2120 mm - 83"
(maximum 14 positions)

FRAMES

Description	P/N	Height (H)	Width (W)	Description	P/N	Height (H)	Width (W)
TERMINAL FRAME 1880 x 600 mm 74" x 24"	SLS-FRAT-600-1880	1880 mm 74"	600 mm 24"	CENTRAL FRAME 1880 x 600 mm 74" x 24"	SLS-FRAC-600-1880	1880 mm 74"	600 mm 24"
TERMINAL FRAME 2000 x 600 mm 79" x 24"	SLS-FRAT-600-2000	2000 mm 79"	600 mm 24"	CENTRAL FRAME 2000 x 600 mm 79" x 24"	SLS-FRAC-600-2000	2000 mm 79"	600 mm 24"
TERMINAL FRAME 2120 x 600 mm 83" x 24"	SLS-FRAT-600-2120	2120 mm 83"	600 mm 24"	CENTRAL FRAME 2120 x 600 mm 83" x 24"	SLS-FRAC-600-2120	2120 mm 83"	600 mm 24"



SET FRONT CROSSBARS

Description	P/N	Length
SET 5 FRONT CROSSBARS FOR GASTRONORM FOODPANS SHELVING	TOP-TRVS-GASTRONORM	372 mm 14"



PAIR OF RAILS

Description	P/N	Length
PAIR OF RAILS FOR GASTRONORM FOODPANS SHELVING (clips for attachment included)	TOP-RAIL-GASTRONORM	600 mm 24"

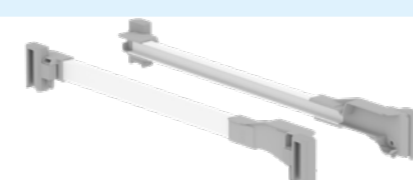

DUST COVER (ACCESSORY)

Description	P/N
DUST COVER FOR GASTRONORM FOODPANS SHELVING	TOP-DC-GN1



Thanks to the central frames, which have drill holes on both sides, it is possible to create linear shelving with several spans of Gastronorm.

In addition, using the same frames, you can also integrate 600 mm deep shelves into your shelving.

To label the different containers, vertical label holders attached to the posts can be added to your shelving (this accessory must already be requested when ordering).



LABEL HOLDER (ACCESSORY)

Description	P/N
LABEL HOLDER BAR FOR H 1880 mm (74") POSTS	LVPROF-12
LABEL HOLDER BAR FOR H 2000 mm (79") POSTS	LVPROF-13
LABEL HOLDER BAR FOR H 2120 mm (83") POSTS	LVPROF-14
LABEL HOLDER 57x40 mm - 2" x 1"	LBLHLD-VER
TRANSPARENT COVER FOR LABEL HOLDER	LBL-HORZCOV

Example of linear shelving with 3 Gastronorm spans provided with label holders and 1 span of shelves.



**SHELVING
BLACK Series**

- Load capacity: up to 250 kg (550 lbs) per shelf
- Simple click-assembly of the shelves, ensuring ultimate flexibility and strength
- Exclusive use of stainless steel screws - none of them visible
- Environmentally friendly all the way from delivery to use
- Temperature range: from -30°C (-22°F) to +90°C (+194°F)
- Flat packaging = less freight costs
- Ideal for cold and freezer rooms – No frost issues with cardboard boxes
- Approved and suitable for direct food contact
- Long Life service
- No special tools needed for assembly
- Lightweight
- Easy to clean
- Fast assembly
- International hygiene certifications (NSF)
- NO RUST – 20 micron anodized aluminum
- Length precision < 3 cm (1¼")



Black recycled polyethylene slats. Fixed positions tiers.

Black Series shelving is characterized by anodic oxidation 20 micron Black Anthracite. With its color, it succeeds in satisfying the aesthetic requirements of food product presentation.

One height of 1700 mm, in two depths: 450 / 600 mm (18" / 24") and in 22 lengths from 400 mm to 1975 mm (16" to 78").

Shelves are in 4 fixed positions with 395 mm (15½") clear span between them.

TERMINAL FRAME

Height (H)		Load Capacity (UDL)		Width (W) 18" - 450 mm		Width (W) 24" - 600 mm	
mm	in.	kg	lbs	P/N	P/N	P/N	P/N
1700	67	1000	2200	KFTN45		KFTN60	

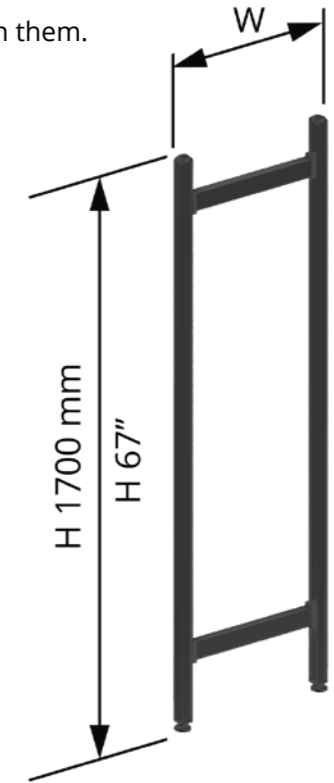

Complete with adjustable base and cap

VENTED ALUMINUM SHELF WITH BLACK PLASTIC SLATS

Length (L)		Load Capacity (UDL)		Width (W) 450 mm - 18"		Width (W) 600 mm - 24"	
mm	in.	kg	lbs	P/N	P/N	P/N	P/N
400	16	250	550	KFN442		KFN592	
475	19	250	550	KFN444		KFN594	
550	22	250	550	KFN446		KFN596	
625	25	250	550	KFN448		KFN598	
700	28	250	550	KFN450		KFN600	
775	31	250	550	KFN452		KFN602	
850	34	250	550	KFN454		KFN604	
925	37	240	530	KFN456		KFN606	
1000	39	240	530	KFN458		KFN608	
1075	42	220	485	KFN460		KFN610	
1150	45	220	485	KFN462		KFN612	
1225	48	220	485	KFN464		KFN614	
1300	51	200	440	KFN466		KFN616	
1375	54	200	440	KFN468		KFN618	
1450	57	200	440	KFN470		KFN620	
1525	60	180	400	KFN472		KFN622	
1600	63	180	400	KFN474		KFN624	
1675	66	180	400	KFN476		KFN626	
1750	69	150	330	KFN478		KFN628	
1825	72	150	330	KFN480		KFN630	
1900	75	120	260	KFN482		KFN632	
1975	78	110	240	KFN484		KFN634	

BLACK ANTHRACITE POLYETHYLENE SLATS

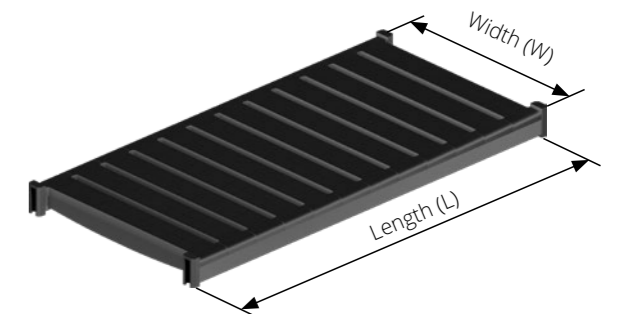

Including 4 connecting plastic clips to the frames



HIGH DENSITY SHELVING SYSTEM

High density shelving system allows better utilization of space, increasing the capacity storage compared to standard fixed shelving.
 Made of 20-micron anodized aluminum profiles, the shelving is entirely stainless and ideal for cold storage rooms.

The shelf slats are removable and dishwasher safe.

Slats can be made of polyethylene or aluminum, certified for direct food contact.
 Polyethylene is nontoxic, chemical resistant, low hygroscopic absorption and rustproof.
 All bolts are stainless steel and are hidden inside the structure itself.

Wear-resistant and immune to temperature changes.
 Assembly requires no tools.

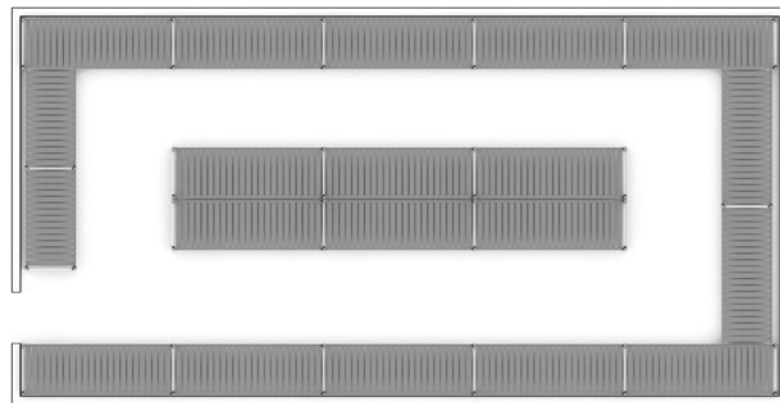

Example of a 4,5x9 m=40,5 m² (14¾' x 29½' = 436 sq ft) cell equipped with STATIC UNITS for 20.7 m² (223 sq ft)

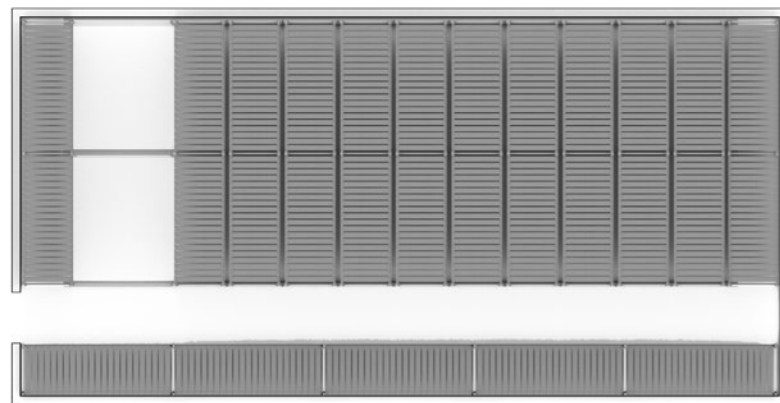

Example of a 4,5x9 m=40,5 m² (14¾' x 29½' = 436 sq ft) cell equipped with MOBILE UNITS for 33.6 m² (361½ sq ft)

**Static
Solution
vs
Mobile
Solution**

**At least
60%
more storage
capacity**

TWO TYPES OF HIGH DENSITY SHELVING SYSTEM



High density shelving system with floor rail



High density shelving system with upper rail

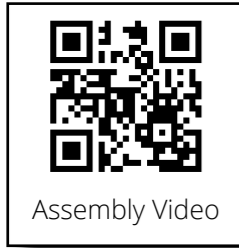
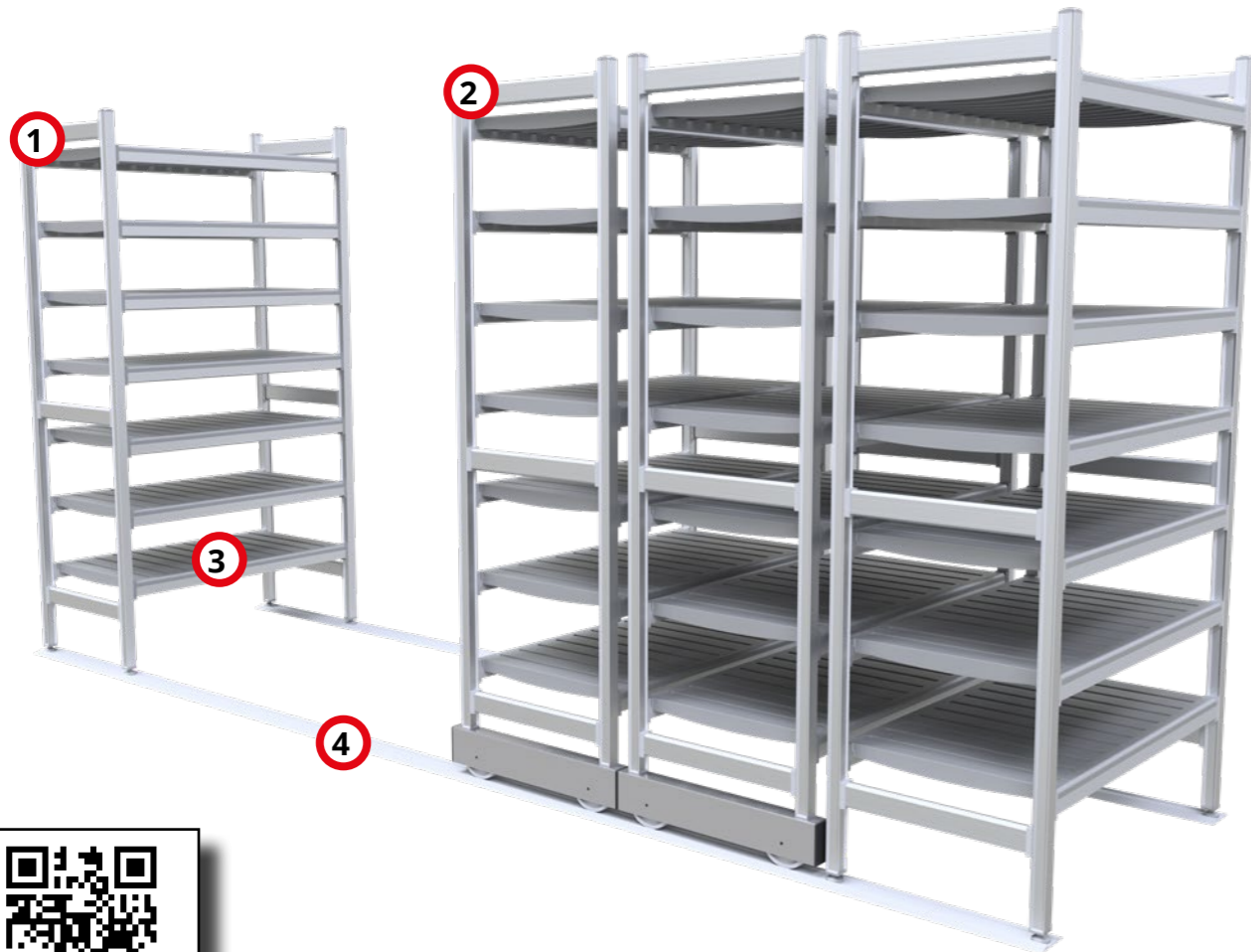

- 1** Static frame
- 2** Mobile frame
- 3** Vented shelf
- 4** Floor rail

1 TERMINAL STATIC FRAME OF HIGH DENSITY SHELVING SYSTEM WITH FLOOR RAIL

Height (H)	Load Capacity (UDL)	Width (W) 300 mm - 12"		Width (W) 375 mm - 15"		Width (W) 450 mm - 18"		Width (W) 525 mm - 21"		Width (W) 600 mm - 24"	
		mm	in.	kg	lbs	P/N	P/N	P/N	P/N	P/N	P/N
1700	67	1000	2200	HDTFR1700T-300S	HDTFR1700T-375S	HDTFR1700T-450S	HDTFR1700T-525S	HDTFR1700T-600S			
1850	73	1000	2200	HDTFR1850T-300S	HDTFR1850T-375S	HDTFR1850T-450S	HDTFR1850T-525S	HDTFR1850T-600S			
2000	79	1000	2200	HDTFR2000T-300S	HDTFR2000T-375S	HDTFR2000T-450S	HDTFR2000T-525S	HDTFR2000T-600S			
2150	85	1000	2200	HDTFR2150T-300S	HDTFR2150T-375S	HDTFR2150T-450S	HDTFR2150T-525S	HDTFR2150T-600S			

1 CENTRAL STATIC FRAME OF HIGH DENSITY SHELVING SYSTEM WITH FLOOR RAIL

Height (H)	Load Capacity (UDL)	Width (W) 300 mm - 12"		Width (W) 375 mm - 15"		Width (W) 450 mm - 18"		Width (W) 525 mm - 21"		Width (W) 600 mm - 24"	
		mm	in.	kg	lbs	P/N	P/N	P/N	P/N	P/N	P/N
1700	67	1000	2200	HDTFR1700C-300S	HDTFR1700C-375S	HDTFR1700C-450S	HDTFR1700C-525S	HDTFR1700C-600S			
1850	73	1000	2200	HDTFR1850C-300S	HDTFR1850C-375S	HDTFR1850C-450S	HDTFR1850C-525S	HDTFR1850C-600S			
2000	79	1000	2200	HDTFR2000C-300S	HDTFR2000C-375S	HDTFR2000C-450S	HDTFR2000C-525S	HDTFR2000C-600S			
2150	85	1000	2200	HDTFR2150C-300S	HDTFR2150C-375S	HDTFR2150C-450S	HDTFR2150C-525S	HDTFR2150C-600S			



Complete with adjustable base and cap

2 TERMINAL MOBILE FRAME OF HIGH DENSITY SHELVING SYSTEM WITH FLOOR RAIL

Height (H)	Load Capacity (UDL)	Width (W) 450 mm - 18"		Width (W) 525 mm - 21"		Width (W) 600 mm - 24"			
		mm	in.	kg	lbs	P/N	P/N	P/N	P/N
1700	67	1000	2200	HDTFR1700T-450M	HDTFR1700T-525M	HDTFR1700T-600M			
1850	73	1000	2200	HDTFR1850T-450M	HDTFR1850T-525M	HDTFR1850T-600M			
2000	79	1000	2200	HDTFR2000T-450M	HDTFR2000T-525M	HDTFR2000T-600M			
2150	85	1000	2200	HDTFR2150T-450M	HDTFR2150T-525M	HDTFR2150T-600M			

2 CENTRAL MOBILE FRAME OF HIGH DENSITY SHELVING SYSTEM WITH FLOOR RAIL

Height (H)	Load Capacity (UDL)	Width (W) 450 mm - 18"		Width (W) 525 mm - 21"		Width (W) 600 mm - 24"			
		mm	in.	kg	lbs	P/N	P/N	P/N	P/N
1700	67	1000	2200	HDTFR1700C-450M	HDTFR1700C-525M	HDTFR1700C-600M			
1850	73	1000	2200	HDTFR1850C-450M	HDTFR1850C-525M	HDTFR1850C-600M			
2000	79	1000	2200	HDTFR2000C-450M	HDTFR2000C-525M	HDTFR2000C-600M			
2150	85	1000	2200	HDTFR2150C-450M	HDTFR2150C-525M	HDTFR2150C-600M			



Complete with mobile base

3 VENTED ALUMINUM SHELF WITH PLASTIC SLATS

Height (H)	Load Capacity (UDL)	Width (W) 300 mm - 12"		Width (W) 375 mm - 15"		Width (W) 450 mm - 18"		Width (W) 525 mm - 21"		Width (W) 600 mm - 24"	
		mm	in.	kg	lbs	P/N	P/N	P/N	P/N	P/N	P/N
700	28	250	550	KFS300	KFS375	KFS450	KFS525	KFS600			
775	31	250	550	KFS302	KFS377	KFS452	KFS527	KFS602			
850	34	250	550	KFS304	KFS379	KFS454	KFS529	KFS604			
925	37	240	530	KFS306	KFS381	KFS456	KFS531	KFS606			
1000	39	240	530	KFS308	KFS383	KFS458	KFS533	KFS608			
1075	42	220	485	KFS310	KFS385	KFS460	KFS535	KFS610			
1150	45	220	485	KFS312	KFS387	KFS462	KFS537	KFS612			
1225	48	220	485	KFS314	KFS389	KFS464	KFS539	KFS614			
1300	51	200	440	KFS316	KFS391	KFS466	KFS541	KFS616			
1375	54	200	440	KFS318	KFS393	KFS468	KFS543	KFS618			
1450	57	200	440	KFS320	KFS395	KFS470	KFS545	KFS620			
1525	60	180	400	KFS322	KFS397	KFS472	KFS547	KFS622			

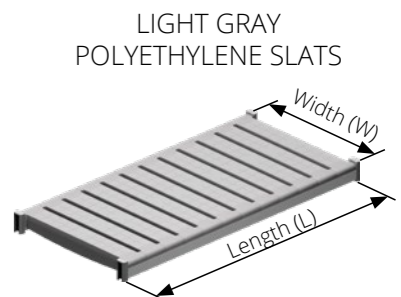

LIGHT GRAY POLYETHYLENE SLATS

Including 4 connecting plastic clips to the frames

ATTENZIONE:

For safety reasons, the depths 300 and 375 mm (12" and 15") are not available for MOBILE UNITS.

ALUMINUM FLOOR RAIL

Pos.	P/N	Description
4	HD-FR	Tailor made rail



ALUMINUM FLOOR RAIL JUNCTION

Pos.	P/N	Description
4	HD-FR-LJ	Junction for extremely long floor rails



ADDITIONAL LOWER RAIL FIXING

In case you want to further secure the lower rail, you can order the end stops P/N **HD-FR-STOPPER** (pack of 2)



High density shelving system with upper rail has the same characteristics as High density shelving system with floor rail but with the advantage of no floor encumbrance.

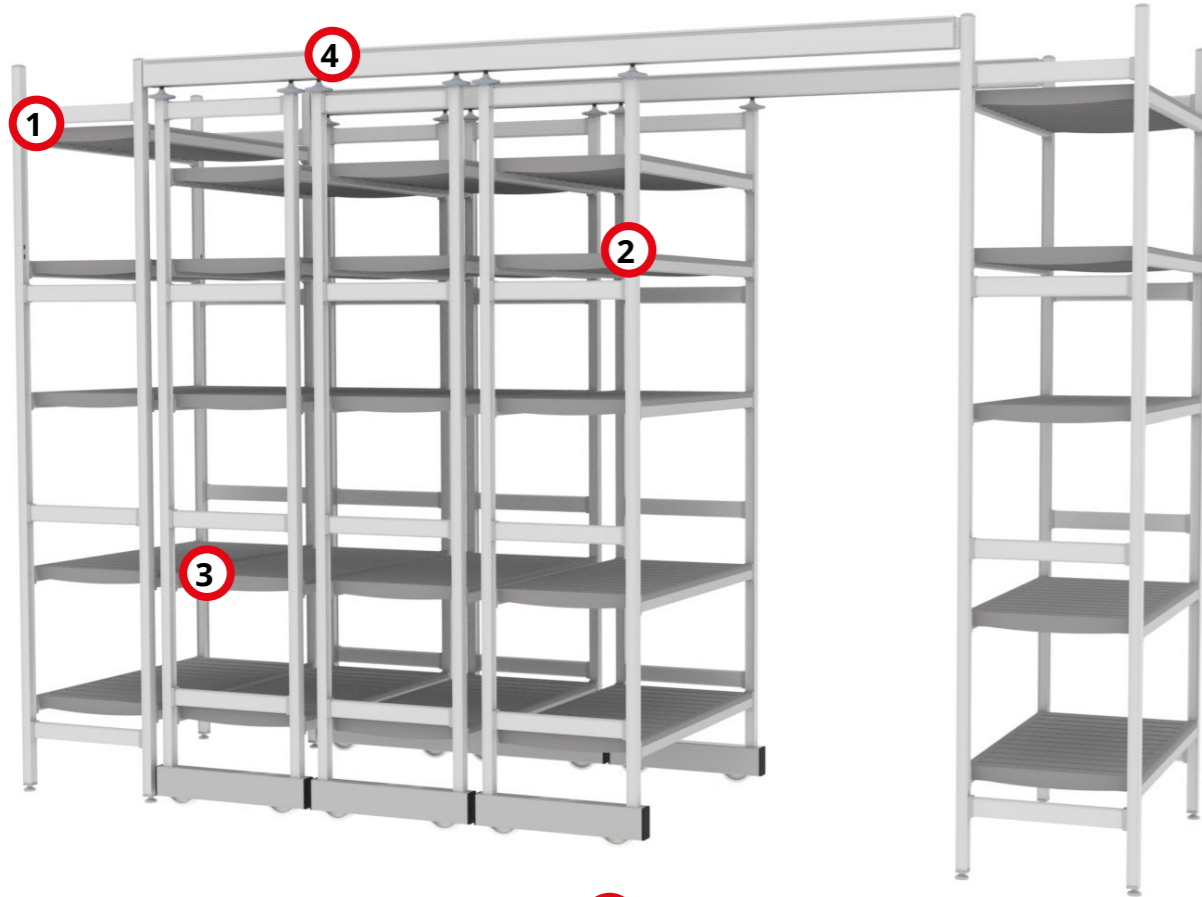

- 1** Static frame
- 2** Mobile frame
- 3** Vented shelf
- 4** Upper rail

1 TERMINAL STATIC FRAME OF HIGH DENSITY SHELVING SYSTEM WITH UPPER RAIL

Height (H)	Load Capacity (UDL)		Width (W)	Width (W)	Width (W)	Width (W)	Width (W)
	mm	in.	300 mm - 12"	375 mm - 15"	450 mm - 18"	525 mm - 21"	600 mm - 24"
2000	79	1000 2200	HDTUR2000T-300S	HDTUR2000T-375S	HDTUR2000T-450S	HDTUR2000T-525S	HDTUR2000T-600S
2150	85	1000 2200	HDTUR2150T-300S	HDTUR2150T-375S	HDTUR2150T-450S	HDTUR2150T-525S	HDTUR2150T-600S
2450	96	1000 2200	HDTUR2450T-300S	HDTUR2450T-375S	HDTUR2450T-450S	HDTUR2450T-525S	HDTUR2450T-600S

1 CENTRAL STATIC FRAME OF HIGH DENSITY SHELVING SYSTEM WITH UPPER RAIL

Height (H)	Load Capacity (UDL)		Width (W)	Width (W)	Width (W)	Width (W)	Width (W)
	mm	in.	300 mm - 12"	375 mm - 15"	450 mm - 18"	525 mm - 21"	600 mm - 24"
2000	79	1000 2200	HDTUR2000C-300S	HDTUR2000C-375S	HDTUR2000C-450S	HDTUR2000C-525S	HDTUR2000C-600S
2150	85	1000 2200	HDTUR2150C-300S	HDTUR2150C-375S	HDTUR2150C-450S	HDTUR2150C-525S	HDTUR2150C-600S
2450	96	1000 2200	HDTUR2450C-300S	HDTUR2450C-375S	HDTUR2450C-450S	HDTUR2450C-525S	HDTUR2450C-600S



Complete with adjustable base and cap

2 TERMINAL MOBILE FRAME OF HIGH DENSITY SHELVING SYSTEM WITH UPPER RAIL

Height (H)	Load Capacity (UDL)		Width (W)	Width (W)	Width (W)
	mm	in.	450 mm - 18"	525 mm - 21"	600 mm - 24"
2000	79	1000 2200	HDTUR2000T-450M	HDTUR2000T-525M	HDTUR2000T-600M
2150	85	1000 2200	HDTUR2150T-450M	HDTUR2150T-525M	HDTUR2150T-600M
2450	96	1000 2200	HDTUR2450T-450M	HDTUR2450T-525M	HDTUR2450T-600M

2 CENTRAL MOBILE FRAME OF HIGH DENSITY SHELVING SYSTEM WITH UPPER RAIL

Height (H)	Load Capacity (UDL)		Width (W)	Width (W)	Width (W)
	mm	in.	450 mm - 18"	525 mm - 21"	600 mm - 24"
2000	79	1000 2200	HDTUR2000C-450M	HDTUR2000C-525M	HDTUR2000C-600M
2150	85	1000 2200	HDTUR2150C-450M	HDTUR2150C-525M	HDTUR2150C-600M
2450	96	1000 2200	HDTUR2450C-450M	HDTUR2450C-525M	HDTUR2450C-600M



Complete with mobile base

3 VENTED ALUMINUM SHELF WITH PLASTIC SLATS

Height (H)	Load Capacity (UDL)		Width (W)	Width (W)	Width (W)	Width (W)	Width (W)
	mm	in.	300 mm - 12"	375 mm - 15"	450 mm - 18"	525 mm - 21"	600 mm - 24"
700	28	250 550	KFS300	KFS375	KFS450	KFS525	KFS600
775	31	250 550	KFS302	KFS377	KFS452	KFS527	KFS602
850	34	250 550	KFS304	KFS379	KFS454	KFS529	KFS604
925	37	240 530	KFS306	KFS381	KFS456	KFS531	KFS606
1000	39	240 530	KFS308	KFS383	KFS458	KFS533	KFS608
1075	42	220 485	KFS310	KFS385	KFS460	KFS535	KFS610
1150	45	220 485	KFS312	KFS387	KFS462	KFS537	KFS612
1225	48	220 485	KFS314	KFS389	KFS464	KFS539	KFS614
1300	51	200 440	KFS316	KFS391	KFS466	KFS541	KFS616
1375	54	200 440	KFS318	KFS393	KFS468	KFS543	KFS618
1450	57	200 440	KFS320	KFS395	KFS470	KFS545	KFS620
1525	60	180 400	KFS322	KFS397	KFS472	KFS547	KFS622

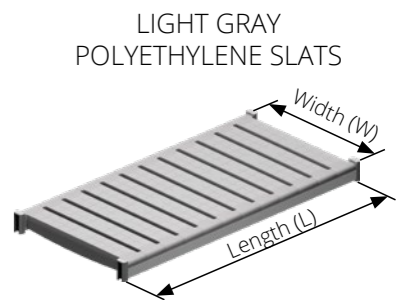

LIGHT GRAY POLYETHYLENE SLATS

Including 4 connecting plastic clips to the frames

ATTENZIONE:

For safety reasons, the depths 300 and 375 mm (12" and 15") are not available for MOBILE UNITS.

ALUMINUM UPPER RAIL

Pos.	P/N	Description
4	HD-UR	Tailor made upper rail

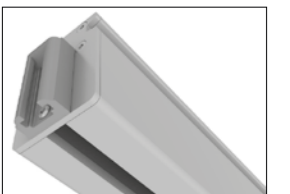

ALUMINUM UPPER RAIL JUNCTION

Pos.	P/N	Description
4	HD-UR-LJ	Junction for extremely long upper rails





**TROLLEYS
TOP Series**

TOP SERIES TROLLEYS



Top Series Trolleys are made with in 20 micron anodized aluminum sections, is entirely stainless and ideal for cold storage, also suitable for temperature changes. The Top Series Trolley has the same features as the Top Series Shelving such as hygiene, non-toxicity, resistance to chemicals and no rust. With its four pivoting and braked resin wheels, it is easily maneuverable even in small environments. Available as a Shelf Trolley or Hanging Trolley.

PAIR OF FRAMES FOR TROLLEY H 1100 mm (41½")

Load capacity 150 kg (330 lbs) / max 3 tiers

P/N	H	L1	L2	W1	W2
TOP-SR110-37	1050 mm (41½")	L + 70 mm (2¾")	L + 125 mm (5")	375 mm (15")	435 mm (17¼")
TOP-SR110-45	1050 mm (41½")	L + 70 mm (2¾")	L + 125 mm (5")	450 mm (18")	510 mm (20")
TOP-SR110-52	1050 mm (41½")	L + 70 mm (2¾")	L + 125 mm (5")	525 mm (21")	585 mm (23")
TOP-SR110-60	1050 mm (41½")	L + 70 mm (2¾")	L + 125 mm (5")	600 mm (24")	660 mm (26")

"L" refers to the shelf chart here below

150 kg (330 lbs) load capacity

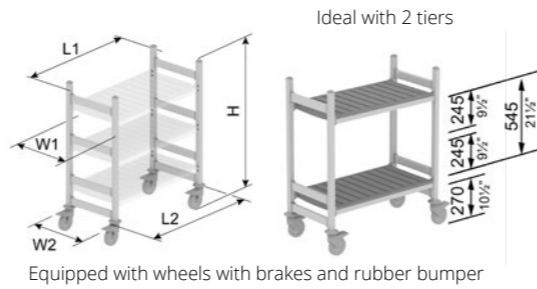

Equipped with wheels with brakes and rubber bumper

PAIR OF FRAMES FOR TROLLEY H 1400 mm (55")

Load capacity 200 kg (440 lbs) / max 4 tiers

P/N	H	L1	L2	W1	W2
TOP-SR140-37	1400 mm (55")	L + 70 mm (2¾")	L + 125 mm (5")	375 mm (15")	435 mm (17¼")
TOP-SR140-45	1400 mm (55")	L + 70 mm (2¾")	L + 125 mm (5")	450 mm (18")	510 mm (20")
TOP-SR140-52	1400 mm (55")	L + 70 mm (2¾")	L + 125 mm (5")	525 mm (21")	585 mm (23")
TOP-SR140-60	1400 mm (55")	L + 70 mm (2¾")	L + 125 mm (5")	600 mm (24")	660 mm (26")

"L" refers to the shelf chart here below

200 kg (440 lbs) load capacity

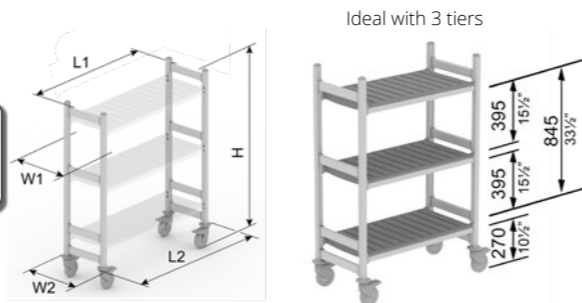

Equipped with wheels with brakes and rubber bumper

PAIR OF FRAMES FOR TROLLEY H 1850 mm (73")

Load capacity 250 kg (550 lbs) / max 4 tiers

P/N	H	L1	L2	W1	W2
TOP-SR185-37	1850 mm (73")	L + 70 mm (2¾")	L + 125 mm (5")	375 mm (15")	435 mm (17¼")
TOP-SR185-45	1850 mm (73")	L + 70 mm (2¾")	L + 125 mm (5")	450 mm (18")	510 mm (20")
TOP-SR185-52	1850 mm (73")	L + 70 mm (2¾")	L + 125 mm (5")	525 mm (21")	585 mm (23")
TOP-SR185-60	1850 mm (73")	L + 70 mm (2¾")	L + 125 mm (5")	600 mm (24")	660 mm (26")

"L" refers to the shelf chart here below

250 kg (550 lbs) load capacity

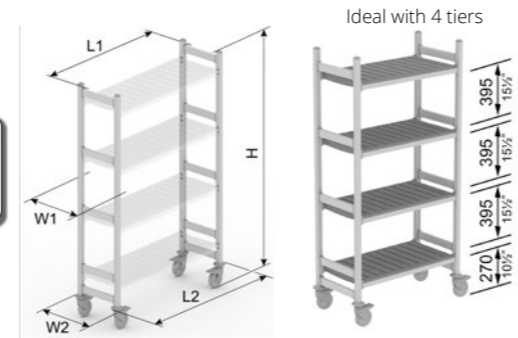

Equipped with wheels with brakes and rubber bumper

INNER UPRIGHTS HANGING BARS

Length (L)	P/N
700 mm (28 in.)	KFG008
775 mm (31 in.)	KFG009
850 mm (34 in.)	KFG010
925 mm (37 in.)	KFG011
1000 mm (39 in.)	KFG012
1075 mm (42 in.)	KFG013
1150 mm (45 in.)	KFG014

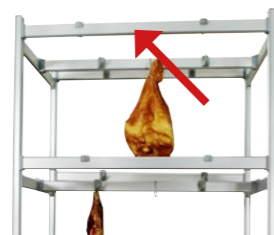

250 kg (550 lbs) load capacity

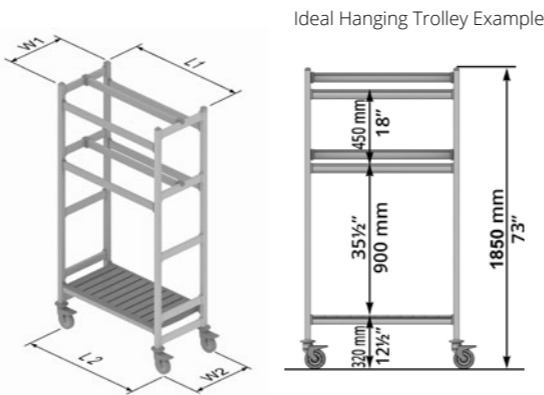

Ideal Hanging Trolley Example

INNER FRAMES HANGING BARS

Length (L)	P/N
700 mm (28 in.)	KFGL08
775 mm (31 in.)	KFGL09
850 mm (34 in.)	KFGL10
925 mm (37 in.)	KFGL11
1000 mm (39 in.)	KFGL12
1075 mm (42 in.)	KFGL13
1150 mm (45 in.)	KFGL14

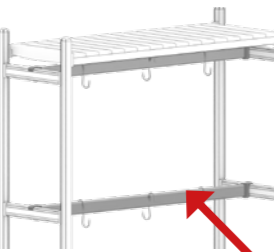

VENTED ALUMINUM SHELF WITH PLASTIC SLATS

Height (H)	Load Capacity (UDL)	Width (W)	Width (W)	Width (W)	Width (W)	Width (W)		
		300 mm - 12"	375 mm - 15"	450 mm - 18"	525 mm - 21"	600 mm - 24"		
mm	in.	kg	lbs	P/N	P/N	P/N	P/N	P/N
400	16	250	550	KFS292	KFS367	KFS442	KFS517	KFS592
475	19	250	550	KFS294	KFS369	KFS444	KFS519	KFS594
550	22	250	550	KFS296	KFS371	KFS446	KFS521	KFS596
625	25	250	550	KFS298	KFS373	KFS448	KFS523	KFS598
700	28	250	550	KFS300	KFS375	KFS450	KFS525	KFS600
775	31	250	550	KFS302	KFS377	KFS452	KFS527	KFS602
850	34	250	550	KFS304	KFS379	KFS454	KFS529	KFS604
925	37	240	530	KFS306	KFS381	KFS456	KFS531	KFS606
1000	39	240	530	KFS308	KFS383	KFS458	KFS533	KFS608
1075	42	220	485	KFS310	KFS385	KFS460	KFS535	KFS610
1150	45	220	485	KFS312	KFS387	KFS462	KFS537	KFS612
1225	48	220	485	KFS314	KFS389	KFS464	KFS539	KFS614
1300	51	200	440	KFS316	KFS391	KFS466	KFS541	KFS616
1375	54	200	440	KFS318	KFS393	KFS468	KFS543	KFS618
1450	57	200	440	KFS320	KFS395	KFS470	KFS545	KFS620
1525	60	180	400	KFS322	KFS397	KFS472	KFS547	KFS622
1600	63	180	400	KFS324	KFS399	KFS474	KFS549	KFS624
1675	66	180	400	KFS326	KFS401	KFS476	KFS551	KFS626

For different types of shelves please go to page 22.

LIGHT GRAY POLYETHYLENE SLATS

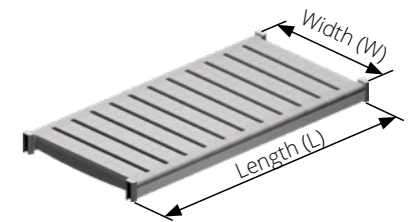

Including 4 connecting plastic clips to the frames

SHELF POLYETHYLENE SLATS FOR DISPLAY SHELVING

Length (L)	Load Capacity (UDL)	Width (W)		Description
		600 mm - 24"	600 mm - 24"	
mm	in.	kg	lbs	P/N
400	16	250	550	KFD592 Display shelf with fall arresting bar 24"x 16" (600x400 mm)
475	19	250	550	KFD594 Display shelf with fall arresting bar 24"x 19" (600x475 mm)
550	22	250	550	KFD596 Display shelf with fall arresting bar 24"x 22" (600x550 mm)
625	25	250	550	KFD598 Display shelf with fall arresting bar 24"x 25" (600x625 mm)
700	28	250	550	KFD600 Display shelf with fall arresting bar 24"x 28" (600x700 mm)
775	31	250	550	KFD602 Display shelf with fall arresting bar 24"x 31" (600x775 mm)
850	34	250	550	KFD604 Display shelf with fall arresting bar 24"x 34" (600x850 mm)
925	37	240	530	KFD606 Display shelf with fall arresting bar 24"x 37" (600x925 mm)
1000	39	240	530	KFD608 Display shelf with fall arresting bar 24"x 39" (600x1000 mm)
1075	42	220	485	KFD610 Display shelf with fall arresting bar 24"x 42" (600x1025 mm)
1150	45	220	485	KFD612 Display shelf with fall arresting bar 24"x 45" (600x1150 mm)
1225	48	220	485	KFD614 Display shelf with fall arresting bar 24"x 48" (600x1225 mm)
1300	51	200	440	KFD616 Display shelf with fall arresting bar 24"x51" (600x1300 mm)
1375	54	200	440	KFD618 Display shelf with fall arresting bar 24"x54" (600x1375 mm)
1450	57	200	440	KFD620 Display shelf with fall arresting bar 24"x57" (600x1450 mm)
1525	60	180	400	KFD622 Display shelf with fall arresting bar 24"x60" (600x1525 mm)
1600	63	180	400	KFD624 Display shelf with fall arresting bar 24"x63" (600x1600 mm)
1675	66	180	400	KFD626 Display shelf with fall arresting bar 24"x66" (600x1675 mm)

LIGHT GRAY POLYETHYLENE SLATS

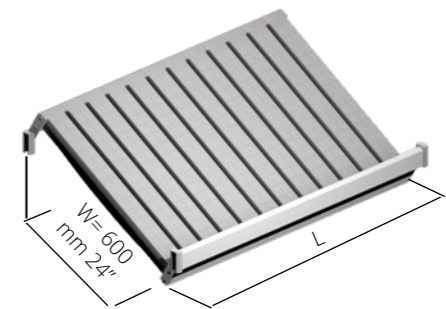

Including 4 connecting plastic clips to the frames

LONGITUDINAL FALL ARRESTING BAR HEAVY DUTY

Length(L)	P/N	Length(L)		P/N
		mm	in.	
400	KFG004	1225	48	KFG015
475	KFG005	1300	51	KFG016
550	KFG006	1375	54	KFG017
625	KFG007	1450	57	KFG018
700	KFG008	1525	60	KFG019
775	KFG009	1600	63	KFG020
850	KFG010	1675	66	KFG021
925	KFG011	1750	69	KFG022
1000	KFG012	1825	72	KFG023
1075	KFG013	1900	75	KFG024
1150	KFG014	1975	78	KFG025





TRAY TROLLEYS
Kombi

Lightweight, robust, modular and stainless.

Our tray trolley has been studied and conceived to satisfy the multiple needs that that you may experience in local self-service as well as in large hotels every day.

It consists of a sturdy supporting structure in light alloy protected against corrosion (anodized 20 microns).

The Tray Trolley comes always with side panels, made of composite aluminum HQ, available in 8 different colours, all with gloss or matt finishing, including 3 standard colors.

The trays are placed in stainless steel racks made of rods or "L" shape.

The span between the supports can be 75, 100, 125, 150, 175 mm (3", 4", 5", 6", 7") or custom made.

The Tray Trolley can accommodate GN, EN, UN, Trapezoidal or special trays, from 7 to a maximum of 32 trays, with 1 or 2 trays per support.

Wheels are made of galvanized steel, rotating and with bumpers; two of them are equipped with a brake.

Total load capacity of Tonon's tray trolley is 120 kg (260 lbs).

Total height of the tray trolley is 1680 mm (66").

If our standard configurations don't satisfy your needs, we can always study a customized solution to suit your need.

Accessories

Top panel with fall arresting bars.

Back panel with fixing parts.

Bottom panel.

Resin or foamed polyurethane wheels.

Custom panel print.

Pair of handles made of impact-resistant resin.

AVAILABLE PANEL COLOURS

	RAL 9016 White Gloss / Matt		RAL 9005 Black Gloss / Matt		RAL 9006 / 9016 Silver / White Matt / Matt
--	--	--	--	--	---

*special colors on request



Stainless Steel Rod

ONE COMPARTMENT TRAY TROLLEYS

TWO COMPARTMENTS TRAY TROLLEYS

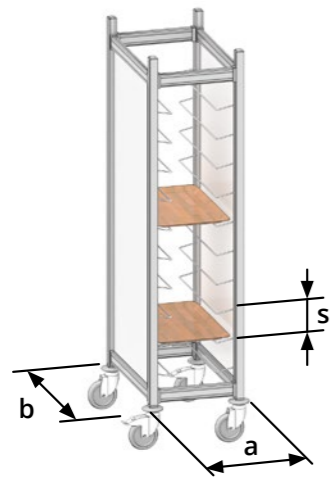

ONE COMPARTMENT
ONE TRAY EACH TIER

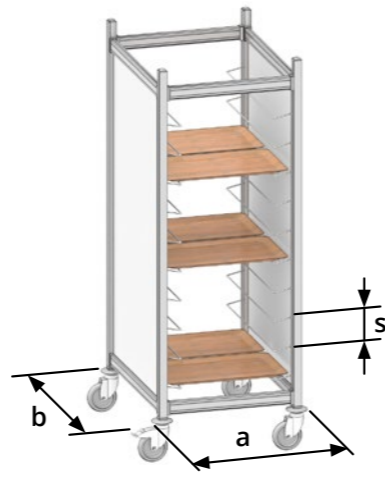

ONE COMPARTMENT
TWO TRAYS EACH TIER

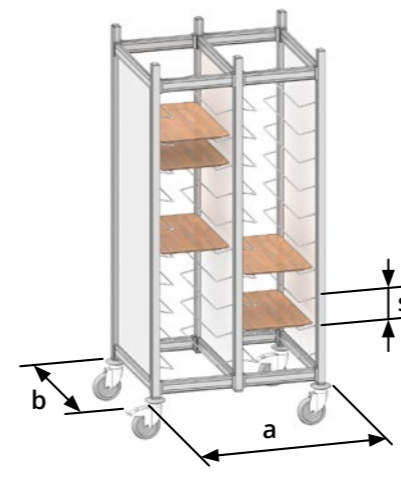

TWO COMPARTMENTS
ONE TRAY EACH TIER

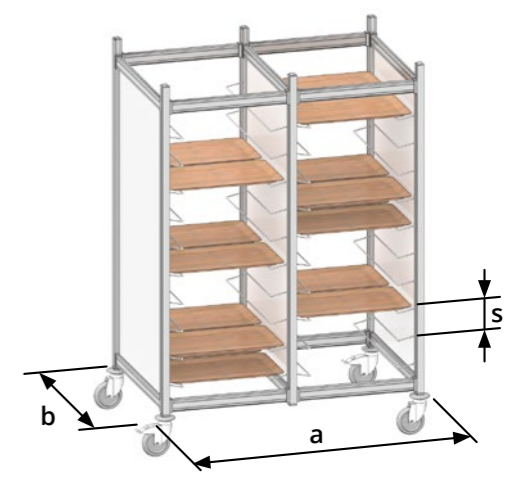

TWO COMPARTMENTS
TWO TRAYS EACH TIER

ONE COMPARTMENT TROLLEY H 1680 mm (H 66") WITH ONE TRAY EACH TIER

Tray Disposal	Tray Model	N° Max Trays	Trays Span (s)	Trolley Dimensions (a) x (b)	Packaging Dimensions	Weight (kg)	Weight (lbs)	Volume (m³)	Volume (sq ft)	Rod P/N
	GN 530 x 325 mm 20¾" x 12¾"	7	175 mm (7")	460 x 680 H 1680 mm	1730 x 710 H230 mm	22.5	49.5	0.28	3	GZ07N0
		8	150 mm (6")			23	50.7	0.28	3	GZ08N1
		10	125 mm (5")			24	52.9	0.28	3	GZ10N2
		12	100 mm (4")			25	55.1	0.28	3	GZ12N3
		16	75 mm (3")			27	59.5	0.28	3	GZ16N4
	EN 530 x 370 mm 20¾" x 14½"	7	175 mm (7")	505 x 680 H 1680 mm	1730 x 710 H230 mm	22.5	49.6	0.28	3	EZ07N0
		8	150 mm (6")			23	50.7	0.28	3	EZ08N1
		10	125 mm (5")			24	52.9	0.28	3	EZ10N2
		12	100 mm (4")			25	55.1	0.28	3	EZ12N3
		16	75 mm (3")			25	59.5	0.28	3	EZ16N4

TWO COMPARTMENTS TROLLEY H 1680 mm (H 66") WITH ONE TRAY EACH TIER

Tray Disposal	Tray Model	N° Max Trays	Trays Span (s)	Trolley Dimensions	Packaging Dimensions	Weight (kg)	Weight (lbs)	Volume (m³)	Volume (sq ft)	Rod P/N
	GN 530 x 325 mm 20¾" x 12¾"	14	175 mm (7")	(a) x (b) 830 x 680 H 1680 mm	Two boxes 1730 x 710 H230 mm	36.5	80.5	0.56	6.02	GZ14N1
		16	150 mm (6")			37.5	82.6	0.56	6.02	GZ16N2
		20	125 mm (5")			39.5	87	0.56	6.02	GZ20N3
		24	100 mm (4")			41.5	91.4	0.56	6.02	GZ24N4
		32	75 mm (3")			45.5	100.3	0.56	6.02	GZ32N5
	EN 530 x 370 mm 20¾" x 14½"	14	175 mm (7")	(a) x (b) 920 x 680 H 1680 mm	Two boxes 1730 x 710 H230 mm	37	81.5	0.56	6.02	EZ14N1
		16	150 mm (6")			38	83.7	0.56	6.02	EZ16N2
		20	125 mm (5")			40	88.10	0.56	6.02	EZ20N3
		24	100 mm (4")			42	92.6	0.56	6.02	EZ24N4
		32	75 mm (3")			46	101.4	0.56	6.02	EZ32N5
	UN 457 x 356 mm 18" x 14"	14	175 mm (7")	(a) x (b) 890 x 610 H 1680 mm	Two boxes 1730 x 640 H230 mm	36.5	80.5	0.51	5.48	UZ14N1
		16	150 mm (6")			37.5	82.6	0.51	5.48	UZ16N2
20		125 mm (5")	39.5			87	0.56	6.02	UZ20N3	
24		100 mm (4")	41.5			91.4	0.51	5.48	UZ24N4	
32		75 mm (3")	45.5			100.3	0.51	5.48	UZ32N5	

ONE COMPARTMENT TROLLEY H 1680 mm (H 66") WITH TWO TRAYS EACH TIER

Tray Disposal	Tray Model	N° Max Trays	Trays Span (s)	Trolley Dimensions (a) x (b)	Packaging Dimensions	Weight (kg)	Weight (lbs)	Volume (m³)	Volume (sq ft)	Rod P/N
	GN 530 x 325 mm 20¾" x 12¾"	14	175 mm (7")	665 x 820 H 1680 mm	1730 x 850 H230 mm	25.5	56.2	0.34	3½	GZ14N5
		16	150 mm (6")			26	57.3	0.34	3½	GZ16N6
		20	125 mm (5")			27	59.5	0.34	3½	GZ20N7
		24	100 mm (4")			28	61.7	0.28	3	GZ24N8
		32	75 mm (3")			30	66.1	0.34	3½	GZ32N9
	EN 530 x 370 mm 20¾" x 14½"	14	175 mm (7")	665 x 910 H 1680 mm	1730 x 940 H230 mm	25.5	56.2	0.37	4	EZ14N5
		16	150 mm (6")			26.5	57.3	0.37	4	EZ16N6
		20	125 mm (5")			27.5	59.5	0.37	4	EZ20N7
		24	100 mm (4")			28.5	61.7	0.37	4	EZ24N8
		32	75 mm (3")			30.5	66.1	0.37	4	EZ32N9
	UN 457 x 356 mm 18" x 14"	14	175 mm (7")	595 x 910 H 1680 mm	1730 x 940 H230 mm	25.5	56.2	0.37	4	UZ14N0
		16	150 mm (6")			26	57.3	0.37	4	UZ16N1
20		125 mm (5")	27			59.5	0.37	4	UZ20N2	
24		100 mm (4")	28			61.7	0.37	4	UZ24N3	
32		75 mm (3")	30			66.1	0.37	4	UZ32N4	

TWO COMPARTMENTS TROLLEY H 1680 mm (H 66") WITH TWO TRAYS EACH TIER

Tray Disposal	Tray Model	N° Max Trays	Trays Span (s)	Trolley Dimensions	Packaging Dimensions	Weight (kg)	Weight (lbs)	Volume (m³)	Volume (sq ft)	Rod P/N
	GN 530 x 325 mm 20¾" x 12¾"	28	175 mm (7")	(a) x (b) 1240 x 820 H 1680 mm	Two boxes 1730 x 850 H230 mm	41.5	91.4	0.68	7.31	GZ28N6
		32	150 mm (6")			42.5	93.7	0.68	7.31	GZ32N7
	EN 530 x 370 mm 20¾" x 14½"	28	175 mm (7")	(a) x (b) 1240 x 910 H 1680 mm	Two boxes 1730 x 940 H230 mm	42	92.5	0.75	8.07	EZ28N6
		32	150 mm (6")			43	94.7	0.75	8.07	EZ32N7



ONE COMPARTMENT TRAY TROLLEYS

TRAY TROLLEY FOR TRAPEZOIDAL TRAYS

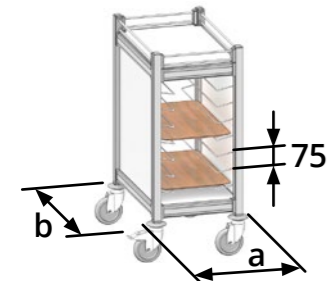

ONE COMPARTMENT
ONE TRAY EACH TIER

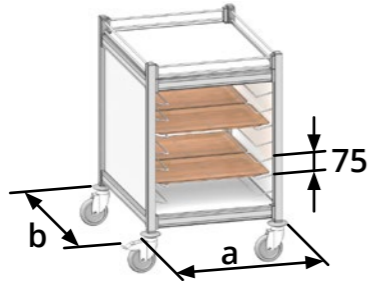

ONE COMPARTMENT
TWO TRAYS EACH TIER

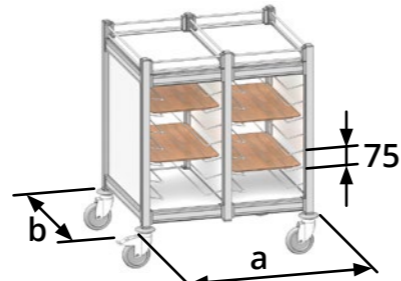

TWO COMPARTMENTS
ONE TRAY EACH TIER

ONE COMPARTMENT TROLLEY H 950 mm (H 37") WITH ONE TRAY EACH TIER

Tray Disposal	Tray Model	N° Max Trays	Trays Span (s)	Trolley Dimensions (a) x (b)	Packaging Dimensions	Weight (kg)	Weight (lbs)	Volume (m³)	Volume (sq ft)	Rod P/N
	GN 530 x 325 mm 20¾" x 12¾"	7	75 mm (3")	460 x 680 H 950 mm 18" x 27" H 37"	1000 x 710 H230 mm 39½" x 28" x H 9"	20.5	45.2	0.16	1.72	GB07N0
	EN 530 x 370 mm 20¾" x 14½"			505 x 680 H 950 mm 20" x 27" H 37"	1000 x 710 H230 mm 39½" x 28" x H 9"	21	46.3	0.16	1.72	EB07N0

The EN tray trolley is suitable also for UN trays

ONE COMPARTMENT TROLLEY H 950 mm (H 37") WITH TWO TRAYS EACH TIER

Tray Disposal	Tray Model	N° Max Trays	Trays Span (s)	Trolley Dimensions (a) x (b)	Packaging Dimensions	Weight (kg)	Weight (lbs)	Volume (m³)	Volume (sq ft)	Rod P/N
	GN 530 x 325 mm 20¾" x 12¾"	14	75 mm (3")	665 x 820 H 950 mm 26" x 32" H 37"	Two boxes 1000 x 850 H230 mm 39½" x 33½" x H 9"	23	50.7	0.20	2.15	GB14N1
	EN 530 x 370 mm 20¾" x 14½"			665 x 910 H 950 mm 26" x 36" H 37"	Two boxes 1000 x 940 H230 mm 39½" x 37" x H 9"	23.5	51.8	0.22	2.36	EB14N1
	UN 457 x 356 mm 18" x 14"			595 x 910 H 950 mm 23½" x 36" H 37"	Two boxes 1000 x 940 H230 mm 39½" x 37" x H 9"	23	50.7	0.22	2.36	UB14N1

TWO COMPARTMENTS TROLLEY H 950 mm (H 37") WITH ONE TRAY EACH TIER

Tray Disposal	Tray Model	N° Max Trays	Trays Span (s)	Trolley Dimensions (a) x (b)	Packaging Dimensions	Weight (kg)	Weight (lbs)	Volume (m³)	Volume (sq ft)	Rod P/N
	GN 530 x 325 mm 20¾" x 12¾"	14	75 mm (3")	830 x 680 H 950 mm 33" x 27" H 37"	Two boxes 1000 x 710 H230 mm 39½" x 28" x H 9"	30	66	0.33	3.55	GB14N2
	EN 530 x 370 mm 20¾" x 14½"			920 x 680 H 950 mm 36" x 27" H 37"	Two boxes 1000 x 710 H230 mm 39½" x 28" x H 9"	30.5	67.2	0.33	3.55	EB14N2
	UN 457 x 356 mm 18" x 14"			890 x 610 H 950 mm 35" x 24" H 37"	Two boxes 1000 x 710 H230 mm 39½" x 28" x H 9"	30	66	0.29	3.12	UB14N2

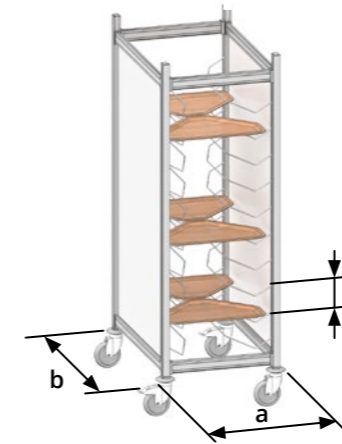

ONE COMPARTMENT
TWO TRAYS EACH TIER

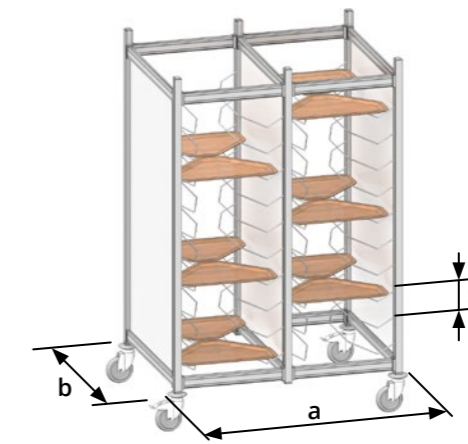

TWO COMPARTMENTS
TWO TRAYS EACH TIER

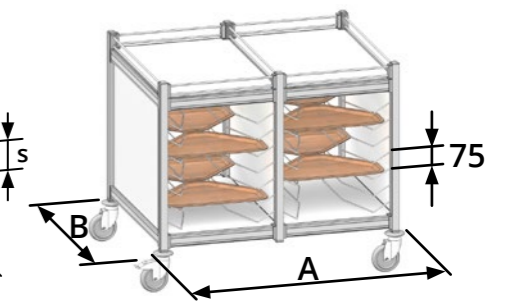

TWO COMPARTMENTS
TWO TRAYS EACH TIER

ONE COMPARTMENT TROLLEY H 1680 mm (H 66") WITH TWO TRAYS EACH TIER

Tray Disposal	Tray Model	N° Max Trays	Trays Span (s)	Trolley Dimensions (a) x (b)	Packaging Dimensions	Weight (kg)	Weight (lbs)	Volume (m³)	Volume (sq ft)	Rod P/N
	TZ 480 x 340 mm 19" x 13½"	14	175 mm (7")	615 x 870 H 1680 mm 24" x 34" H 66"	1730 x 900 H230 mm 18" x 35½" x H 9"	24	53	0.72	7.75	TZ14N0
		16	150 mm (6")			25	55.1	0.72	7.75	TZ16N1
		20	125 mm (5")			27	59.5	0.72	7.75	TZ20N2
		24	100 mm (4")			29	63.9	0.72	7.75	TZ24N3
		32	75 mm (3")			33	72.7	0.72	7.75	TZ32N4

TWO COMPARTMENTS TROLLEY H 1680 mm (H 66") WITH TWO TRAYS EACH TIER

Tray Disposal	Tray Model	N° Max Trays	Trays Span (s)	Trolley Dimensions (a) x (b)	Packaging Dimensions	Weight (kg)	Weight (lbs)	Volume (m³)	Volume (sq ft)	Rod P/N
	TZ 480 x 340 mm 19" x 13½"	28	175 mm (7")	1140 x 870 H 1680 mm 45" x 34" H 66"	3 boxes 1730 x 900 H270 mm 18" x 35½" x H 10½"	42	92.5	1.30	13.99	TZ28N1
		32	150 mm (6")			43	94.7	1.30	13.99	TZ32N2

TWO COMPARTMENTS TROLLEY H 950 mm (H 37") WITH TWO TRAYS EACH TIER

Tray Disposal	Tray Model	N° Max Trays	Trays Span (s)	Trolley Dimensions (a) x (b)	Packaging Dimensions	Weight (kg)	Weight (lbs)	Volume (m³)	Volume (sq ft)	Rod P/N
	TZ 480 x 340 mm 19" x 13½"	28	75 mm (3")	1140 x 870 H 950 mm 45" x 34" H 37"	3 boxes 1730 x 900 H270 mm 18" x 35½" x H 10½"	31	68.3	0.74	7.96	TB28N0



BACK PANEL FOR ONE COMPARTMENT TROLLEY H 1680 mm (66")

Trolley dimensions	mm	460 x 680	665x820	505x680	665x910	595x910	615x870
	in	18" x 27"	26" x 32"	20" x 27"	26" x 36"	23½" x 36"	24" x 34"
Weight	kg	4.9	5.9	4.9	6.6	6.6	6.3
	lbs	10.8	13.0	10.8	14.5	14.5	13.8
P/N		STDP01	STDP02	STDP03	STDP04	STDP05	STDP06

BACK PANEL FOR TWO COMPARTMENTS TROLLEY H 1680 mm (66")

Trolley dimensions	mm	830x680	1240x820	920x680	1240x910	890x610	1140x870
	in	33" x 27"	49" x 32"	36" x 27"	49" x 36"	35" x 24"	45" x 34"
Weight	kg	9.8	11.8	9.8	13.2	13.2	12.6
	lbs	21.6	26.0	21.6	29.1	29.1	27.7
P/N		STDP07	STDP08	STDP09	STDP10	STDP11	STDP12

BACK PANEL FOR ONE COMPARTMENT TROLLEY H 950 mm (37")

Trolley dimensions	mm	460x680	665x820	505x680	665x910	595x910
	in	18" x 27"	26" x 32"	20" x 27"	26" x 36"	23½" x 36"
Weight	kg	2.7	3.3	2.7	3.7	3.7
	lbs	5.9	7.2	5.9	8.1	8.1
P/N		STDP21	STDP22	STDP23	STDP24	STDP25

BACK PANEL FOR TWO COMPARTMENTS TROLLEY H 950 mm (37")

Trolley dimensions	mm	830x680	920x680	890x610	1140x870
	in	33" x 27"	36" x 27"	35" x 24"	45" x 34"
Weight	kg	5.4	5.4	5.0	7.0
	lbs	11.9	11.9	11.0	15.4
P/N		STDP26	STDP27	STDP28	STDP29

TOP PANEL WITH FALL ARRESTING BARS ONE COMPARTMENT TRAY TROLLEY

Tray type	GN		EN		UN	TZ	
Trolley dimensions	mm	460 x 680	665x820	505x680	665x910	595x910	615x870
	in	18" x 27"	26" x 32"	20" x 27"	26" x 36"	23½" x 36"	24" x 34"
Weight	kg	1.8	2.8	1.9	3.0	2.8	2.8
	lbs	3.9	6.2	4.2	6.6	6.2	6.2
P/N		1CPS01	1CPS02	1CPS03	1CPS04	1CPS05	1CPS06

TOP PANEL WITH FALL ARRESTING BARS TWO COMPARTMENTS TRAY TROLLEY

Tray type	GN		EN		UN	TZ	
Trolley dimensions	mm	830x680	1240x820	920x680	1240x910	890x610	1140x870
	in	33" x 27"	49" x 32"	36" x 27"	49" x 36"	35" x 24"	45" x 34"
Weight	kg	3.6	5.6	3.8	6.0	5.6	5.6
	lbs	7.9	12.3	8.3	13.2	12.3	12.3
P/N		2CPS01	2CPS02	2CPS03	2CPS04	2CPS05	2CPS06

BOTTOM PANEL - ONE COMPARTMENT TRAY TROLLEY

Tray type	GN		EN		UN	TZ	
Trolley dimensions	mm	460 x 680	665x820	505x680	665x910	595x910	615x870
	in	18" x 27"	26" x 32"	20" x 27"	26" x 36"	23½" x 36"	24" x 34"
Weight	kg	1.3	2.3	1.4	2.5	2.3	2.3
	lbs	2.8	5.0	3.0	5.5	5.0	5.0
P/N		1CPI01	1CPI02	1CPI03	1CPI04	1CPI05	1CPI06

BOTTOM PANEL - TWO COMPARTMENTS TRAY TROLLEY

Tray type	GN		EN		UN	TZ	
Trolley dimensions	mm	830x680	1240x820	920x680	1240x910	890x610	1140x870
	in	33" x 27"	49" x 32"	36" x 27"	49" x 36"	35" x 24"	45" x 34"
Weight	kg	2.6	4.6	2.8	5.0	4.6	4.6
	lbs	5.7	10.1	6.1	11.0	10.1	10.1
P/N		2CPI01	2CPI02	2CPI03	2CPI04	2CPI05	2CPI06



Back panels

Removable top panel for easy cleaning



Removable bottom panel for easy cleaning



AVAILABLE PANEL COLOURS

	RAL 9016 White Gloss / Matt		RAL 9005 Black Gloss / Matt		RAL 9006 / 9016 Silver / White Matt / Matt
--	--	--	--	--	---

* special colors on request



Example of One compartment tray trolley H 1680 (66") with two tray each tier.
Optionals: Back panel + top panel with fall arresting bars + bottom panel + special color on request.

CUSTOM PRINT PANELS

P/N	Description
COLP01	Back panel for single compartment trolley H 1680 mm (66")
COLP02	Back panel for double compartment trolley H 1680 mm (66")
COLP03	Back panel for single compartment trolley H 950 mm (37")
COLP04	Back panel for double compartment trolley H 950 mm (37")
COLL01	Side panel for H 1680 mm (66") trolley
COLL02	Side panel for H 950 mm (37") trolley



Custom print panel

PAIR OF HANDLES

Material	Black resin
Weight	kg 0.24 lbs 0.52
P/N	MANI01



Pair of handles

Items for Spare Parts

RESIN WHEEL D. 125 mm (5")

Type	P/N	Weight
With brake	RURE01	0.70 kg 1.54 lbs
Without brake	RURE02	0.55 kg 1.21 lbs

GALVANIZED WHEEL D. 125 mm (5")

Type	P/N	Weight
With brake	RUZN01	0.86 kg 1.89 lbs
Without brake	RUZN02	0.70 kg 1.54 lbs

FOAMED WHEEL D. 125 mm (5")

Type	P/N	Weight
With brake	RUPU01	0.90 kg 1.98 lbs
Without brake	RUPU02	0.76 kg 1.67 lbs

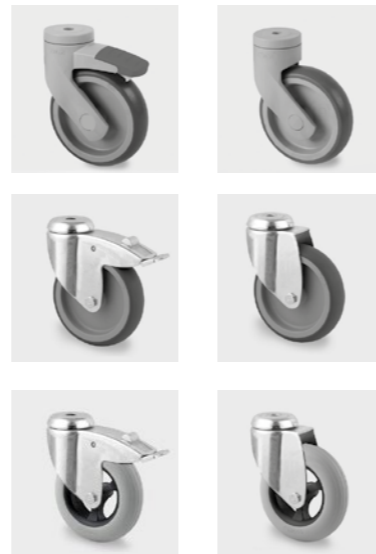

SPARE SIDE PANEL - H1680 mm (66") TRAY TROLLEY

Trolley dimensions	mm	610	680	820	870	910
	in	24"	27"	32"	34"	36"
Weight	kg	4.4	4.9	5.9	6.2	6.5
	lbs	9.7	10.8	13.0	13.6	14.3
P/N		STDLO1	STDLO2	STDLO3	STDLO4	STDLO5

SPARE SIDE PANEL - H950 mm (37") TRAY TROLLEY

Trolley dimensions	mm	610	680	820	870	910
	in	24"	27"	32"	34"	36"
Weight	kg	2.5	2.7	3.3	3.5	3.7
	lbs	5.5	5.9	7.3	7.7	8.1
P/N		STDL21	STDL22	STDL23	STDL24	STDL25

Side panels (spare)

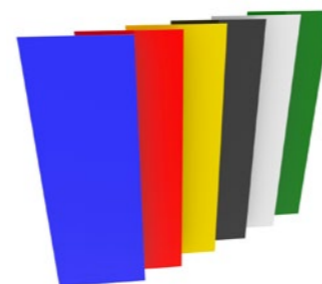

Single compartment tray trolley packaging



Assembly video



Ease of transportation

Flat packaging allows freight cost reduction.

The product is shipped pre-assembled reducing the volume to about one third of the finished product.



Up to 6 trolley each pallet!

~ 1750 x 950 x H1600 mm
~ 69" x 37½" x H 90½"

SMART LABEL

Awarded for Smart Packaging and assembly without tools @ Host 2015



ALUMINUM

Aluminum, thanks to the large quantity of bauxite and its versatility, is the most widely used metal after steel. Aluminum can be used in a vast number of applications and types of recycle due to its characteristics:

- Lightweight but impact resistant.
- Durable.
- Resistant to corrosion.
- Non-toxic and without effects to the taste and the color of foods.
- Hygienically safe (protection against light, air, humidity, odors and microorganisms).
- Non-magnetic: it is not attracted to magnets and can therefore be used in the manufacturing of devices like as radios, radar and stereo .
- Malleable, ductile, easily workable.
- Versatile: can form many alloys, both rigid and flexible.
- 100% recyclable.



Currently a quarter of european needs is met by using aluminum metal second melting, which can be recycled basically forever. The same metal could be used as metal lid of a yogurt container for two months, being recycled as part of a car engine for many years, and being again recycled for a third time.

Recycled aluminum saves 95% of the needed energy to manufacture it from ore, most of the industrialized countries keep on developing systems of scrap collection that can now retrieve up to 70% of all aluminum components of cars.

Since the use of aluminum in transportation, household appliances, packaging and other sectors is growing, the collection and recycle of the metal are always more important.

HIGH DENSITY POLYETHYLENE

The high-density polyethylene (HDPE) is a thermoplastic polymer derived from oil widely used in food and beverage industry. HDPE has little ramifications so that the intermolecular forces and tensile resistance are higher than in fluid varieties of polyethylene. It has high mechanical strength and good rigidity and it's resistant to acids, alkalis, saline solutions and organic solvents.



HDPE has a high specific strength and can withstand high temperatures (120° c for short periods, 90° c continuously). In contrast to polypropylene, has an excellent resistance to low temperatures. HDPE, as well as LDPE and pet, is one of the easiest to recycle polymer and it's widely reused thanks to the differentiate urban rubbish collection. HDPE is recycled for the production of liquid containers, bags, packaging, agricultural pipes, bollards, football pitches and artificial wood.

TONON FOR A SUSTAINABLE DEVELOPMENT



Sustainable development meets the needs of present generations without compromising the possibility for future generations to meet their needs, a process where the resource management, the direction of investments, the orientation of technological development and institutional changes live in complete harmony and increase current and future capabilities to satisfy human needs and ambitions.

For this reason, we decided to use only recyclable materials like aluminum and high-density polyethylene to manufacture our products. For example, polyethylene and aluminum are used for the production of a new plastic material, the ecoallene®.

This versatile and durable plastic material, is packaged and sold in the form of granules and it's suitable for use in various sectors of the plastic molding. In Germany, polyethylene and aluminum are used as catalysts in cement kilns. The mixture of polymers and aluminum refuels the furnaces as a form of alternative fuel, usually replacing coal.

In Brazil, a patented machine cleans polyethylene and aluminum in the process of recycling paper. This machine allow higher efficiency in the fiber salvage, and, at the same time, better quality pellets for injection molding. The combined properties of polymers and aluminum allow the production of cardboard sheets to be used in construction.



FLAT PACKAGING

Thanks to the flat packaging, transport volumes are reduced and consequentially the CO2 emissions in the air.



TONON NEDERLAND
Pieter Van Schravendijkstraat 31
2461 VM TER AAR
tel. +31 0637 468765 (Steven)
verkoop@tonon.nl

TONON ASIA PACIFIC
18 Boon Lay Way #09-155 Trade Hub 21
609966 SINGAPORE
tel. +65 9644 6618 (Godfrey)
tap@tonon.com

TONON INDIA
tel. +91 97 4164 2152 (Varun)
varun@tonon.com

TONON USA
119 Evans Oak LN
San Antonio - TX 78216 - U.S.A.
tel. +1 210 4100306 (Daniele)
usa@tonon.com
daniele@tonon.com

TONON SCANDINAVIA
Æblehaven 31 - 5462 Morud
DENMARK
tel. +45 20800003 (Lars)
tel. +45 20800004 (Ole)
scandinavia@tonon.com

TONON AUSTRALIA
Unit 3/18 Birmingham Ave
Villawood NSW 2163
tel. +61 401 411411 (Godfrey)
godfrey@tonon.com.sg

TONON FRANCE
38090 Vaulx Milieu
tel. +33 4 7494 0383
adv@tonon.com

TONON IRELAND
Oristown, Kells, Co. Meath,
A82 X0H7 - Ireland
tel. +353 86 198 0098 (James)
info@tonon.ie

TONON IBÉRIA
tel. +34 646 67 05 32
daniele@tonon.com

TONON MIDDLE EAST
tel. +39 335 81 79 576 (Eric)
tonon@tonon.com

TONON PERÙ
tel. +51 993 508 606
tel. +51 993 508 608
remar@tonon.com



TONON S.R.L.
Via Liguria, 33
10071 Borgaro Torinese (To) - Italy
tel. 011 470 1173 sales@tonon.com

WWW.TONON.COM

